



POWERVAR Sinergy III Rackmount / Tower User Instruction Manual

Sinergy III 120 Volt UPS

- ACDEF700-11 700 VA UPS
- ACDEF1000-11 1000 VA UPS • E024-12 External Battery Cabinet
- ACDEF1500-11 1500 VA UPS • E036-12 External Battery Cabinet
- ACDEF2000-11 2000 VA UPS • E048-12 External Battery Cabinet
- ACDEF3000-11 3000 VA UPS • E072-12 External Battery Cabinet

Sinergy III 200-240 Volt UPS

- ACDEF2000-22 2000 VA UPS • E048-12 External Battery Cabinet
- ACDEF3000-22 3000 VA UPS • E072-12 External Battery Cabinet

This manual contains important instructions for the Sinergy III UPS and External Battery Cabinets. Follow these instructions during the unpacking, installation, and maintenance of the UPS and the External Battery Cabinet. If you have a problem with the UPS or the battery cabinet, please refer to this manual before calling technical support.

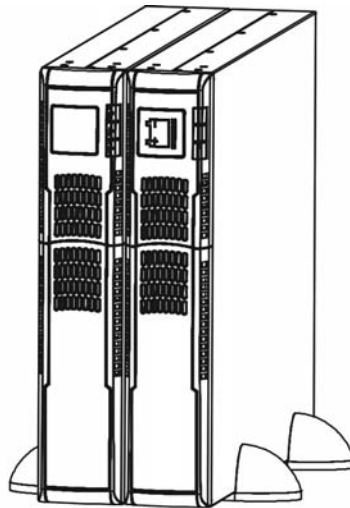

POWERVAR
1450 South Lakeside Drive
Waukegan, IL 60085-8301
T (847) 596-7000
(800) 369-7179
F (847) 596-7100
www.powervar.com

Table of Contents

1. Introduction	1
1.1 Technical Support	1
1.2 FCC Compliance	1
1.3 Safety Compliance	1
1.4 About This Manual	1
1.5 Safety	2
1.5.1 Safety Intended Use	2
1.5.2 General Warnings	2
1.5.3 Safety Notices	2
1.5.4 Battery Safety	4
1.5.5 Repacking of Unit	4
2. Overview	5
2.1 UPS Devices and Batteries	5
2.2 Packing List	5
2.3 Storage	5
2.4 Recharging the UPS During Storage	6
2.5 Environmental Conditions	6
2.6 Floor Loading	6
2.7 Ventilation	6
2.8 Rear Panel View	7
2.8.1 Models : ACDEF700-11, ACDEF1000-11, ACDEF1500-11	7
2.8.2 Model : ACDEF2000-11	7
2.8.3 Model : ACDEF3000-11	7
2.8.4 Model : ACDEF2000-22	8
2.8.5 Model : ACDEF3000-22	8
2.8.4 External Battery Cabinet	9
2.9 LCD Display	10
2.9.1 Rack Display	10
2.9.2 Tower Display	10
2.10 LCD : Display and Functional Description	11
3. Installation	12
3.1 Tower Installation	12
3.2 Rack Installation	13
3.2.1 Assembly Steps	13
3.3 Electrical Preparations	15
3.3.1 Battery Connections	15
4. Setting Up UPS Parameters	17
4.1 Factory Default Settings	17
4.2 Changing Default Settings	17
4.2.1 Output Voltage Setting (item 01)	18
4.2.2 Frequency Converter Enable/Disable (item 02)	18
4.2.3 Output Frequency Setting (item 03)	19
4.2.4 Bypass Mode Enable/Disable when the UPS is off (item 06)	19
4.2.5 Programmable Outlets Enable/Disable (item 07)	19
4.2.6 Programmable Outlets Setting (item 08)	20
4.2.7 LCD Display Direction Setting (item 09)	20
4.2.8 Acceptable Input Voltage Range Setting (item 10)	20
4.2.9 Number of External Battery Cabinets (item 11)	20

5. UPS Operation	21
5.1 UPS input connection	21
5.1.1 LCD Display in Bypass Mode.....	21
5.1.2 LCD Display in Standby Mode.....	21
5.2 Turn on the UPS (Put the UPS in OnLine Mode)	22
5.2.1 LCD Display in OnLine Mode	22
5.3 Connect Devices to the UPS	22
5.4 The UPS in Battery Mode	23
5.4.1 LCD Display in Battery Mode	23
5.5 Turn off the UPS	23
6. Interfaces	24
6.1 Serial Interface COM 3.....	24
6.2 Interface Slot COM	24
7. Emergency Power Off (EPO)	25
8. Maintenance	25
8.1 Cleaning	25
8.2 UPS Storage	25
8.3 Battery Testing	25
8.4 Replacing Batteries.....	26
9. Troubleshooting.....	29
9.1 Troubleshooting Table.....	29
9.2 Audible Alarm.....	31
9.3 LCD Display Abbreviation Index.....	31
9.4 Warning Indicators.....	32
9.5 UPS Fault.....	33
9.5.1 LCD Display in Fault Mode.....	33
9.5.2 Fault Reference Code.....	33
10. Appendix A: Specifications.....	34
10.1 SINERGY III UPS (100 - 120 Volt UPS) Specifications	34
10.2 SINERGY III UPS (200 - 240 Volt UPS) Specifications	44
10.3 Extension battery cabinets for use with Sinergy III UPS's	48
11. Appendix B: Optional Isolated Relay Contacts Card	55
11.1 Description.....	55
11.2 Installation in Sinergy III UPS accessory slot	55
11.3 Isolated Relay Contact Card Operation	56
11.4 Isolated Relay Contact Card Functional Diagrams	57
11.5 Isolated Relay Contact Card Specifications	58
11.6 Instructions for Nortel Meridian PBX Systems	58
12. Appendix C: Warranty.....	59
12.1 Basic Warranty.....	59
12.2 Limitations.....	59
12.3 Battery Life Disclaimer.....	59

1. Introduction

Thank you for selecting this uninterruptible power supply (UPS). POWERVAR's Sinergy III Series UPS offers the most reliable protection from the harmful effects of electrical line disturbances for your computing and communications equipment. POWERVAR's ISO 9001 certification represents our commitment to building world-class products. We take pride in every unit that leaves our facility.

1.1 Technical Support

POWERVAR offers 24-hour technical support. To contact POWERVAR :

T (847) 596-7000

(800) 369-7179

F (847) 596-7100

Please check with technical support before attempting to repair or return any POWERVAR product. If a POWERVAR UPS needs repair or replacement, technical support will issue a return material authorization (RMA) number along with instructions on how to return the UPS.

1.2 FCC Compliance



ATTENTION: Changes or modifications to this unit not expressly approved by the party responsible or in FCC compliance could void the user's authority to operate the equipment.

The 700-3kVA models have been tested and comply with the limits for a Class A digital device, pursuant to Part 15 of FCC Rules. These limits are designed to provide reasonable protection against harmful interference when the UPS is operating in a commercial environment. The UPS generates, uses, and can radiate radio frequency energy. If installation and use is not in accordance with the instruction manual, it may cause harmful interference to radio communications.

1.3 Safety Compliance

UL/cUL listing to UL1778, 4th Edition

CE

CAN/CSA C22.2 No 170.3-05, 2nd Edition

1.4 About This Manual

This manual contains information regarding the installation, operation, and maintenance of the uninterruptible power supply (UPS).

The following symbols are used in this manual:



ATTENTION: Indicates instructions, which if not observed, may endanger reliability of your UPS or security of your data.



CAUTION: Indicates instructions, which if not observed, present risk of electric shock, may endanger your life, your health, reliability of your UPS or the security of your data.

1.5 Safety

1.5.1 Safety Intended Use

- This device serves as an uninterruptible power supply for connected loads. The device is in compliance with all relevant safety regulations concerning information technology equipment for use in an office environment.
- Depending on the type and rating of UPS device, certain configurations of battery extensions may be connected. These battery extensions may only be connected to the compatible basic UPS unit.

1.5.2 General Warnings



CAUTION: POWERVAR considers the safety of personnel to be of paramount importance. For this reason it is essential that procedures relating to safety in this manual be carefully reviewed before commencing work, and properly adhered to later. The user or operator may intervene in the operation of the UPS provided that the instructions laid out in Section 3 “Installation” are strictly followed.



CAUTION: Even when all switches and/or circuit breakers are open, dangerous voltages are present within this unit! There are no user-serviceable parts inside. Only factory authorized technical personnel may carry out any operation that requires protection panels to be opened and/or removed. Any repairs or modifications by the user may result in out-of-warranty repair charges, unsafe electrical conditions, or violation of electrical codes.

1.5.3 Safety Notices

IMPORTANT SAFETY INSTRUCTIONS SAVE THESE INSTRUCTIONS



CAUTION: SAVE THESE INSTRUCTIONS - This Manual Contains Important Instructions that should be followed during installation and maintenance of the UPS and batteries.

- Temperature Rating - Units are acceptable for use in a maximum ambient of 40 °C (104°F).
- For PLUGGABLE EQUIPMENT, the socket-outlet shall be installed near the equipment and shall be easily accessible.
- **CAUTION:** To reduce the risk of fire, connect model **ACDEF3000-11** only to a circuit provided with 30 amperes maximum branch circuit overcurrent protection in accordance with the National Electric Code, ANSI/NFPA 70.
- **CAUTION:** To reduce the risk of fire, connect models **ACDEF700-11, ACDEF1000-11, ACDEF1500-11, and ACDEF2000-11** only to a circuit provided with 20 amperes maximum branch circuit overcurrent protection in accordance with the National Electric Code, ANSI/NFPA 70.



- The units are heavy. Lifting the units into the rack requires a minimum of two people.
- When installing units in racks, do not allow racks to become “top heavy”. Install heaviest equipment (typically the external battery cabinet) near bottom of rack, and install this equipment before installing equipment higher in the rack.
- This equipment services power from more than one source. The output terminals and/or receptacles may have voltage present even when the unit is unplugged. UPS’s present a different safety issue than most electrical equipment because unplugging the UPS puts it into battery mode. Unplugging the UPS does not remove the electrical charge.
- The UPS must be connected to an earthed mains outlet-socket.
- When installing the equipment, ensure that the sum of the leakage current of the UPS and the connected devices does not exceed 3.5mA.
- Make sure that no objects (e.g. pins, necklaces, paper clips, etc.) get inside the device. In emergencies (e.g. damaged case, controls or power cables, penetration of liquids or foreign matter) switch off the device and contact technical support for assistance.



- Transport the unit only in suitable packaging (protected against jolts and shocks).
- If the equipment is moved from a cold environment to a warmer operation location, condensation may occur. Before you switch on the equipment it must be absolutely dry. An acclimatization period of at least two hours is required.
- Place all cords so that nobody can stand on or trip over them. When connecting the device to the power supply, follow the instructions in Section 3 “Installation”.
- Do not connect equipment that will overload the UPS or demand DC-current.
- When cleaning the unit, follow the instructions in Section 8 “Maintenance”.
- Emergency power off (EPO) is located on the rear of the unit (see Section 2.7 “Rear Panel View”). When this connection is open, the logic circuit will immediately shut down the UPS output.

1.5.4 Battery Safety

IMPORTANT SAFETY INSTRUCTIONS SAVE THESE INSTRUCTIONS



CAUTION: The batteries installed in the UPS and within the extended battery cabinets contain electrolyte. Under normal conditions the containers are dry. A damaged battery may leak electrolyte that can be dangerous when in contact with the skin and cause irritation to the eyes. Should this happen, wash the affected part with copious amounts of water and seek immediate medical attention.

- Voltage is always present on the battery terminals.
- Even when discharged, a battery has the capacity to supply a high short circuit current, which in addition to causing damage to the battery itself and to associated cables, may expose the operator to the risk of burns.
- Batteries should not be kept in storage for periods exceeding 6 months at 25°C without being recharged (having been charged to 100% at the beginning of any such period). If these conditions are not respected, the performance of the battery can no longer be guaranteed. It is advisable to recharge the batteries at least once every 4 months.
- Since new batteries often do not provide full capacity after an initial charge, it may be necessary to carry out a number of discharge/recharge cycles before optimum performance is achieved.
- In order to protect the environment, batteries must be disposed of in accordance with the regulations governing disposal/recycling of toxic and harmful waste.

1.5.5 Repacking of Unit

Do not pack equipment until at least two (2) hours have elapsed since the last recharge.

Place the equipment in bags made of material sufficiently porous to allow it to breathe (e.g. 100µm polyethylene).

Do not remove air from the packaging.

When packing the unit for movement by common carrier, place in original or equivalent packaging container.

2. Overview

NOTE: The equipment has been thoroughly checked before shipment. Upon receipt, check the packaging and ensure that the contents are undamaged and that no items are discarded. Any damage must be reported to the shipper and any missing parts must be reported to the supplier immediately. Please keep the original package in a safe place for future use.

2.1 UPS Devices and Batteries

The following table provides an overview of the various versions of the device:

Sinergy III UPS Model	Battery Cabinet Model
ACDEF700-11	E024-12
ACDEF1000-11	E024-12
ACDEF1500-11	E036-12
ACDEF2000-11	E048-12
ACDEF3000-11	E072-12
ACDEF2000-22	E048-12
ACDEF3000-22	E072-12

2.2 Packing List

Unpack the package and check the package contents. The shipping package contains:

UPS Shipping Package	Optional Extended Battery Cabinet
<ol style="list-style-type: none"> 1. One UPS 2. One User Manual 3. Mounting Ears 4. Two Sets of Tower Stands (Feet) 5. Rail Kit 6. USB Cable 	<ol style="list-style-type: none"> 1. One Battery Cabinet 2. One Battery Cable 3. Mounting Ears 4. Two Sets of Tower Stands (Feet and Extensions) 5. Rail Kit

2.3 Storage

If the UPS is to be stored prior to use, it should be stored in a clean, dry environment and away from temperature extremes. It is recommended that the equipment be stored in a temperature controlled, moderate humidity environment. The table below provides the temperature and humidity storage limits:

Storage Data	
Temperature Limits	32°F to 104°F (0°C to +40°C)
Relative Humidity (Non-Condensing)	0% to 90%

NOTE: When storing equipment, every 8°C above 25°C reduces the shelf life of the battery by 50%. More frequent battery charging is required to maintain the batteries in storage at these greater temperatures.

2.4 Recharging the UPS During Storage

Before storing, charge the UPS for five hours. During storage, recharge the battery in accordance with the following table:

Storage Temperature	Recharge Frequency	Charging Duration
-13°F to 104°F (-25°C to +40°C)	Every 3 Months	1-2 Hours
104°F to 113°F (40°C to +45°C)	Every 2 Months	1-2 Hours

2.5 Environmental Conditions

The UPS must be installed on a level and even surface. Install in an area protected from extremes of temperature, water, humidity and the presence of conductive powder or dust. Do not stack units and do not place any objects on top of a unit.

The functional temperature range of the UPS is 32°F to 104°F (0°C to +40°C).

The ideal ambient temperature range is 60°F to 77°F (15°C to 25°C).

Expected battery runtimes and battery life is based on operational temperatures between 68°F and 77°F (20°C and 25°C). Operation of the equipment above 77°F (25°C) reduces the service life of the batteries dramatically.

2.6 Floor Loading

Taking into consideration the weight of the UPS, extended battery cabinets, and any other equipment that may be mounted in an associated rack. Confirm that the floor chosen location is capable of supporting the weight of the combined units.

2.7 Ventilation

It is necessary to leave a minimum space of at least two inches (50 mm) in front and rear of the UPS to allow a flow of air.

2.8 Rear Panel View

2.8.1 Models : ACDEF700-11, ACDEF1000-11 and ACDEF1500-11

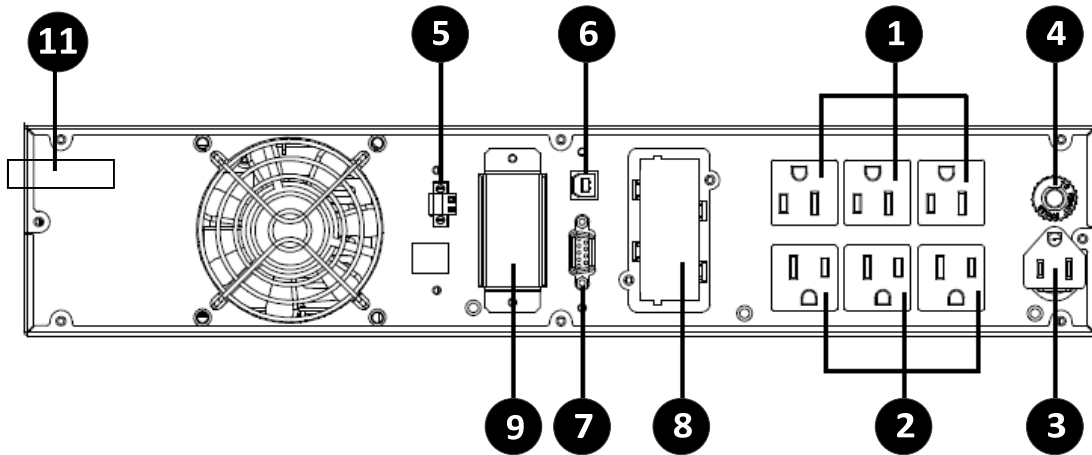

2.8.2 Model : ACDEF2000-11

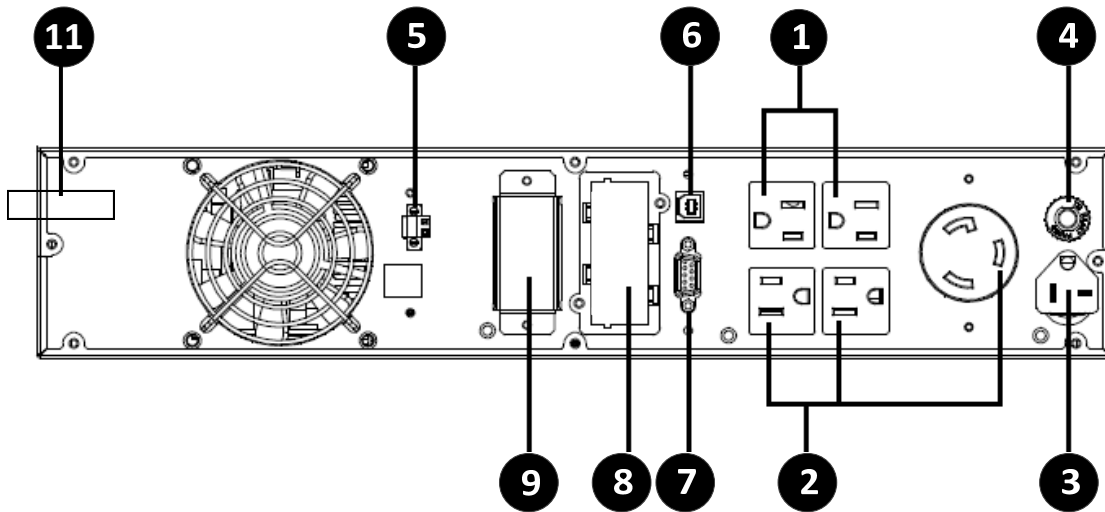

2.8.3 Model : ACDEF3000-11

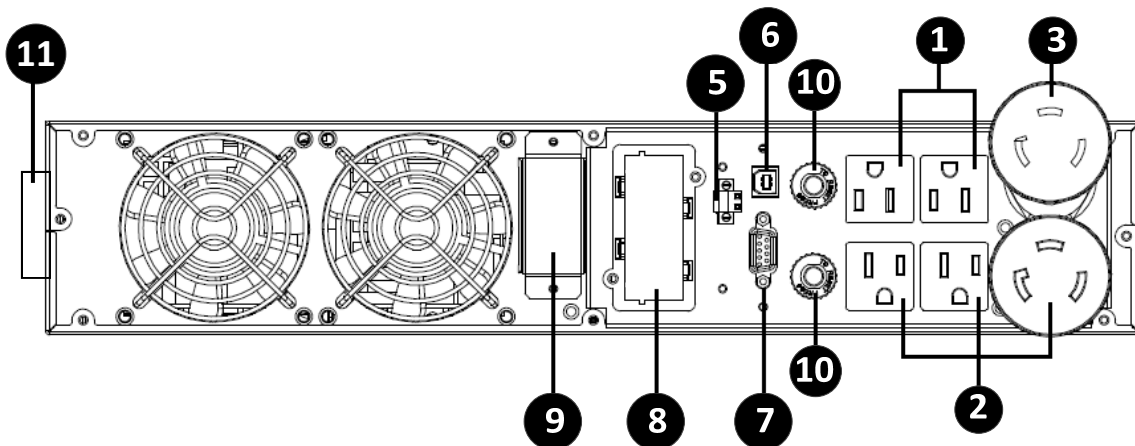

2.8.4 Model : ACDEF2000-22

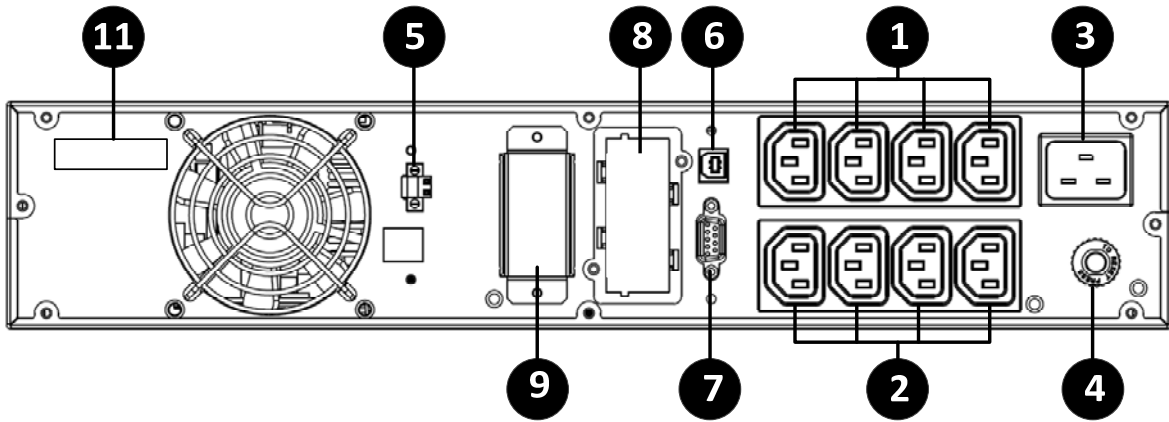

2.8.5 Model : ACDEF3000-22

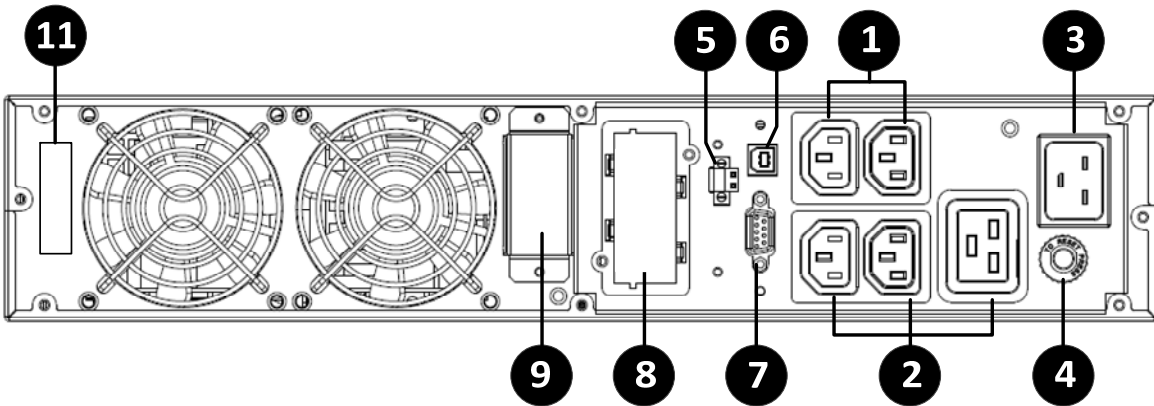

1. Programmable Output Receptacles
2. Direct Output Receptacles
3. AC Input
4. Input Circuit Breaker
5. Emergency Power Off Function Connector (EPO)
6. USB Communication Port
7. RS232 Communication Port
8. SNMP Intelligent Slot
9. External Battery Connector
10. Output Circuit Breaker
11. Serial Number

2.8.4 External Battery Cabinet

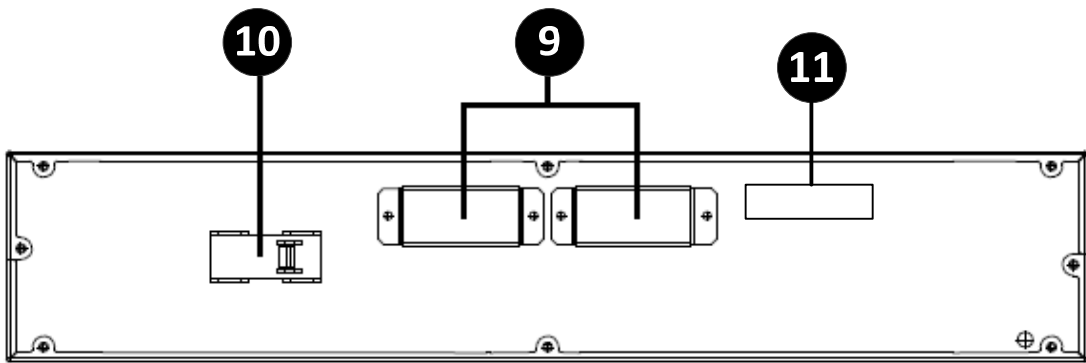

- 9. External Battery Connector
- 10. Output Circuit Breaker
- 11. Serial Number

2.9 LCD Display



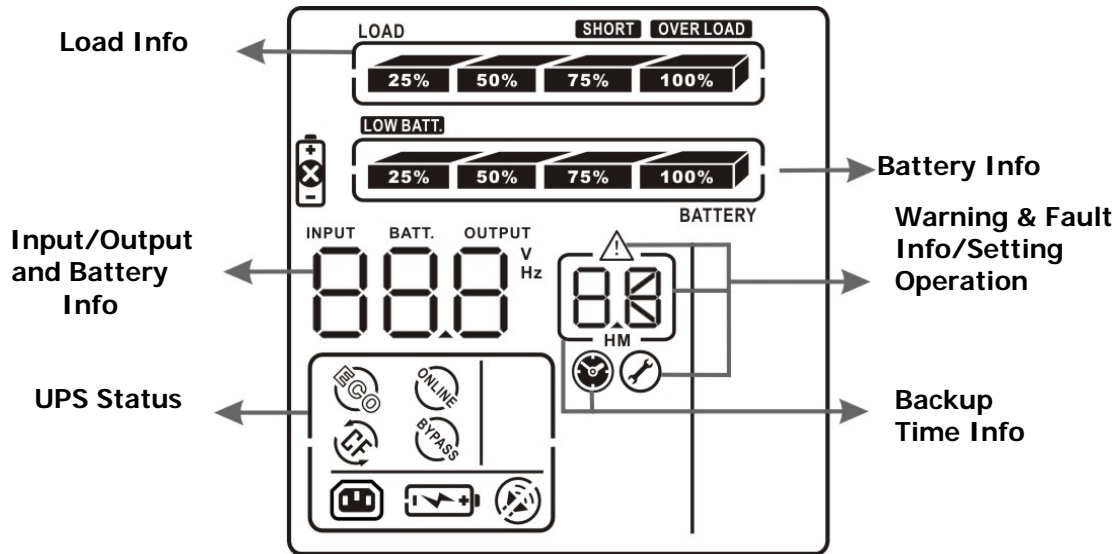



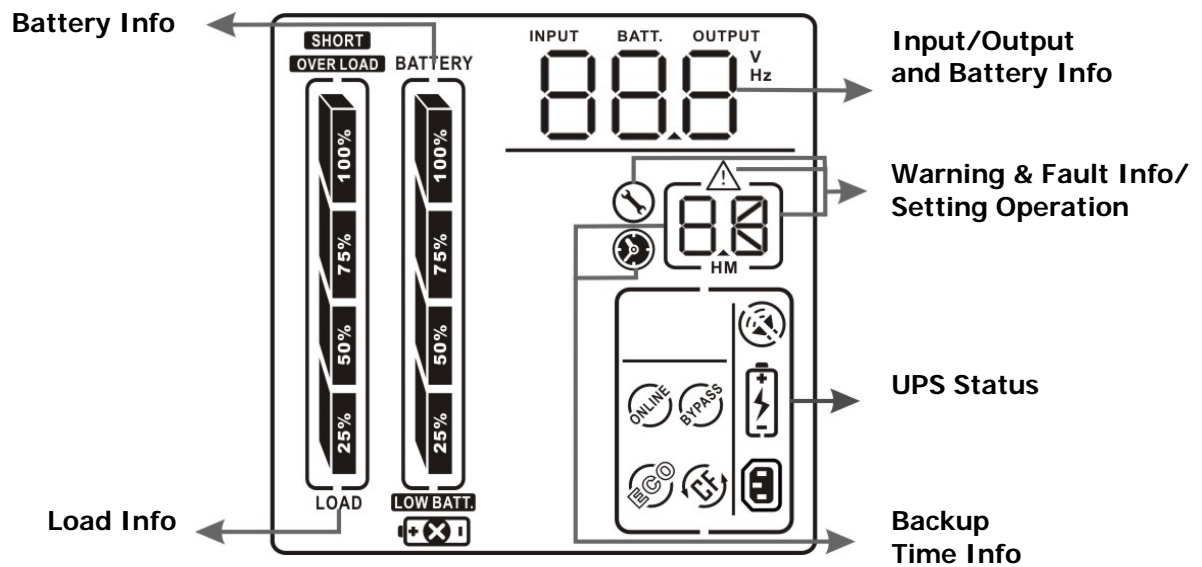











2.9.1 Rack Display



2.9.2 Tower Display



2.10 LCD : Display and Functional Description

Display	Function
Backup time information	
	Indicates the backup time.
	Indicates the backup time. H: hours, M: minutes
Warning & Fault information	
	Indicates that a warning and/or fault has occurred.
	Indicates the warning and fault codes. The codes are listed in sections 9.4 and 9.5.
Setting Operation	
	Indicates the setting information.
Input/Output & Battery information	
	Indicates the input/output voltage, input/output frequency, and battery voltage. V: voltage, Hz: frequency
Load information	
	Indicates load level by 0-25%, 26-50%, 51-75% and 76-100%.
	Indicates overload.
	Indicates that the load or the UPS output is short circuited.
UPS Status	
	Indicates that the programmable outlets are working.
	Indicates that the UPS is in on-line mode.
	Indicates that the UPS is in converter mode.
	Indicates that the UPS is in bypass mode.
	Indicates that the UPS alarm is disabled.
	Indicates that the battery charger is working.
Battery information	
	Indicates the battery level by 0-25%, 26-50%, 51-75%, and 76 - 100%.
	Indicates low battery.
	Indicates that there is something wrong with the battery.

3. Installation

The UPS and external battery cabinet are designed to be rack-mounted in four post frames or to be floor standing in a tower configuration.

3.1 Tower Installation



ATTENTION: Use all supplied mounting hardware on each UPS and extended battery cabinet.

- A. To install standalone, refer to the figure directly below :
Assemble two feet as one tower stand.
Align the two stands.
Put the UPS module in the stands.

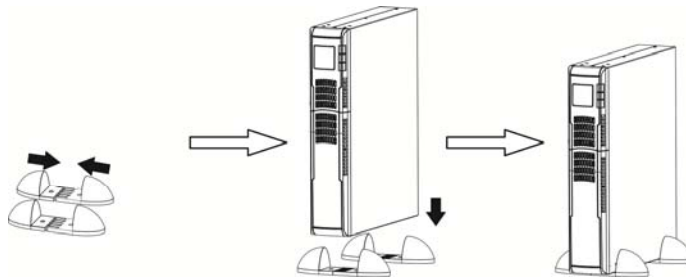

- B. To install a UPS module and one extended battery cabinet, refer to the figure directly below :
Assemble two feet each with an extension as one tower stand.
Align the two stands.
Put the UPS module and external battery cabinet in the stands.

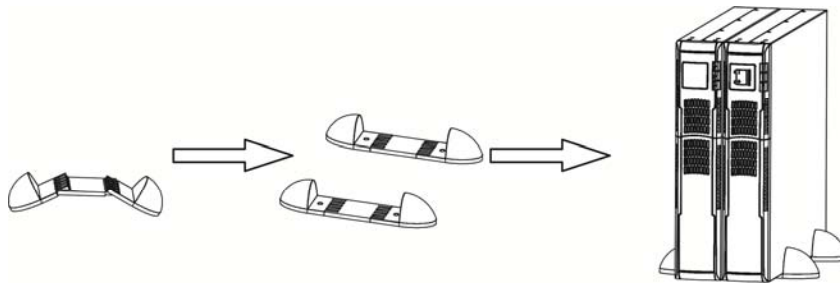

NOTE: When installing the UPS or external battery cabinet with feet, please keep both feet a distance of 2.75in (70mm) from the edge of the unit. See figure below :

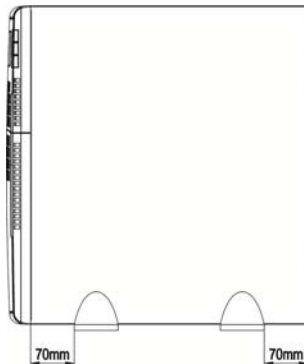

3.2 Rack Installation

The UPS and the external battery cabinets are designed to be rack-mounted in four post frames. The UPS and external battery cabinet use identical mounting hardware and procedures.

NOTE: The rack-mount UPS draws air from the front. If the rack has a door on the front, make sure that there is some clearance between the UPS vents and the rack door.

Because of the weight of these units, two people are recommended to lift and hold into position while all fasteners are secured. Please use the supplied fasteners to attach the supplied mounting brackets to the UPS or external battery cabinet.

If external batteries are included in your installation, please mount them first and as low as possible. Start with the lowest available position and work up. Your UPS should be installed last and end up on the top of all the battery cabinets for proper cable routing.



ATTENTION: Use all supplied mounting hardware on each UPS and external battery cabinet. NEVER depend on lower devices to support other devices.

Included in each rack-mount carton is a rail kit. The rail kit consists of the following components :

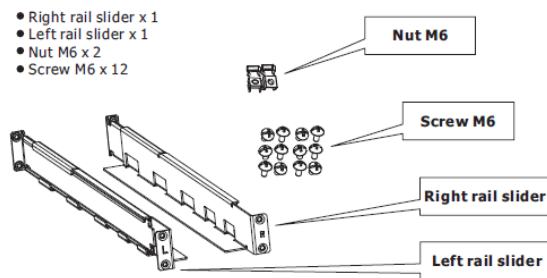

3.2.1 Assembly Steps

Step 1: Use four M6 screws to mount the right and left rail sliders to the two front posts of the four-post rack. Refer to the figure directly below :

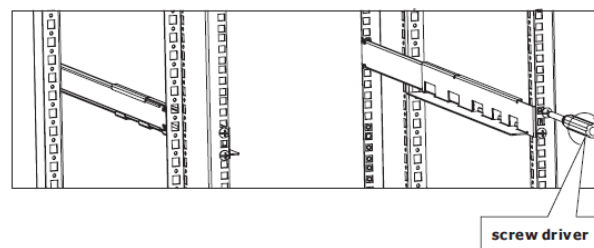

Step 2. Use four M6 screws to mount the right and left rail sliders to the two back posts of the four-post rack.
Refer to the figure directly below :

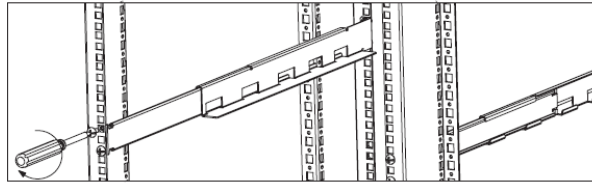

Step 3. Insert one M6 nut into the right and left front posts of the four-post rack for a 2U installation.
Refer to figure directly below :

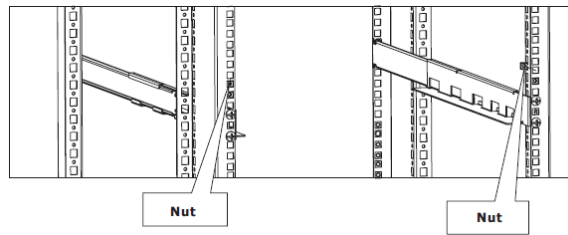

Step 4. Install UPS alone.

Add mounting ears to both sides of the unit and refer to figure directly below :

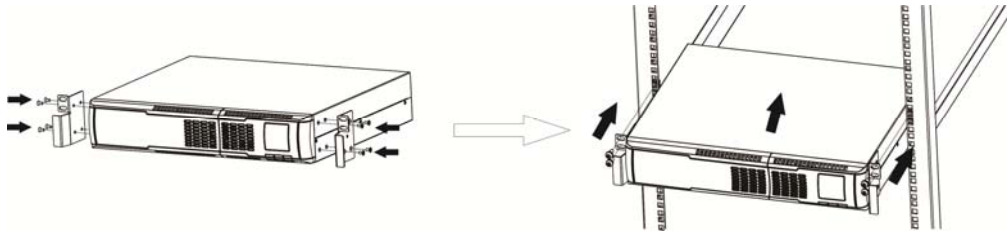

Step 5. Install UPS and external battery cabinet.

Refer to figure directly below :

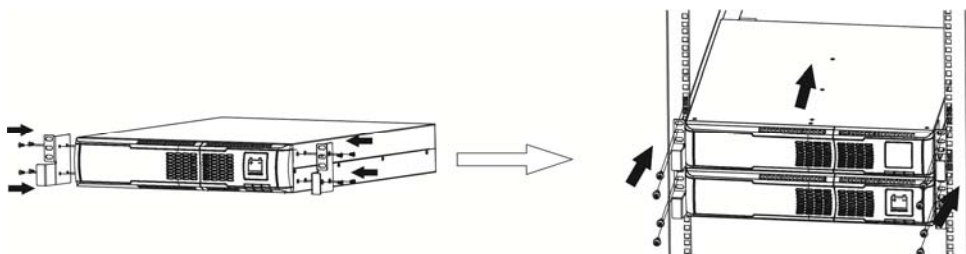

3.3 Electrical Preparations



CAUTION: Before connecting any input wiring to the UPS, take precautions to ensure that all circuits being used are the proper voltage and current required for the UPS.



CAUTION: UPS output receptacles are energized when the UPS is connected to the mains and the bypass is enabled.



CAUTION: Electrical shock hazard. Even when the UPS is disconnected from the mains, hazardous voltages may still exist at the output receptacles of the UPS. The UPS receives power from more than one source - AC input and DC input from batteries. All input sources (AC and DC) must be disconnected before carrying out maintenance work inside the UPS.

3.3.1 Battery Connections



CAUTION: Column one in the table below lists each of the UPS models and column two displays the corresponding model of the extended battery cabinet which must be used with the UPS. **DO NOT USE** any other extended battery cabinet for the corresponding UPS.

UPS Model	Battery Cabinet Model
ACDEF700-11	E024-12
ACDEF1000-11	E024-12
ACDEF1500-11	E036-12
ACDEF2000-11	E048-12
ACDEF3000-11	E072-12
ACDEF2000-22	E048-12
ACDEF3000-22	E072-12



CAUTION: Before connecting a battery cabinet to the UPS, the circuit breaker of the battery pack must be switched to “OFF”. After electrical connection with the UPS is established, the breaker must be switched to “ON”.

NOTE: Each battery cabinet contains two battery connectors. The first battery cabinet is connected to the UPS using the cable supplied with the cabinet. Each additional extension battery cabinet is connected by attaching its cable to the previous cabinet. Refer to the figure below.

If additional battery cabinets (up to 4) are to be used, they should be connected prior to connecting the UPS to the input power. To connect external battery cabinets, follow the steps below:

1. Set the circuit breaker to the “OFF” position.
2. Remove the battery connector cover from the UPS.
3. Remove the battery connector cover from the extended battery cabinet.
4. If there are multiple extended batter cabinets, remove the additional battery connector covers. If not, proceed to Step 5.
5. Connect the supplied battery cable to the extended battery cabinet.
6. Connect the other end of the battery cable to the UPS.
7. For multiple extended battery cabinets, connect the supplied battery cables as shown in the figure below.
8. Set the circuit breaker to the “ON” position.

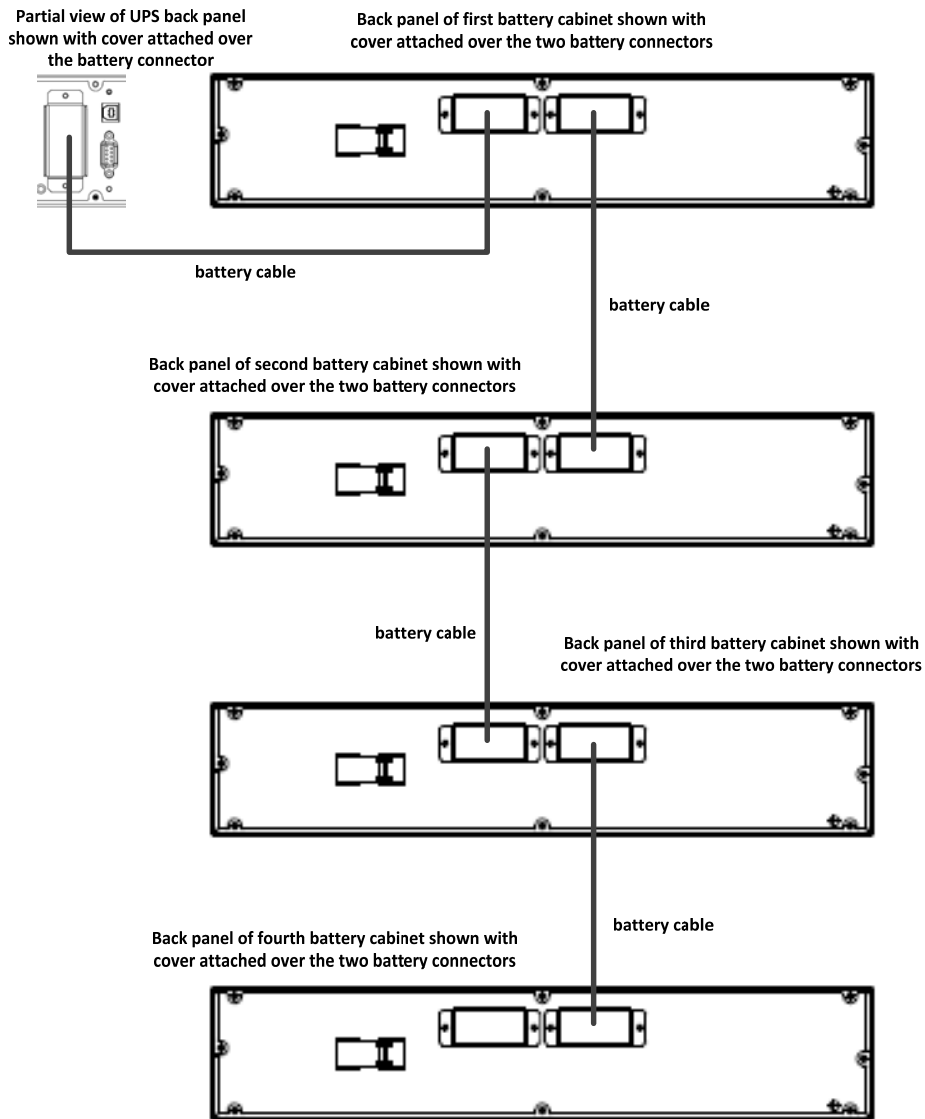

Wiring of four battery cabinets to a single UPS

4. Setting Up UPS Parameters

4.1 Factory Default Settings

The UPS is shipped with the following default factory settings. Refer to the table below and also to the table “LCD Display Abbreviation Index” in Section 9.3.

PARAMETER	FACTORY DEFAULT SETTING	
	100 - 120 Volt Models	200 - 240 Volt Models
Output Voltage	120	208
Frequency Converter	DIS	
Output Frequency	60	
Bypass Mode	ENA	
Programmable Outlets	DIS	
Programmable Outlets Backup Time Setting	2	
LCD Display Direction Setting	RAC	
Acceptable Input Voltage Range Setting	85-135	180-300
Number of External Battery Cabinets	0	

If the factory default settings are acceptable, proceed directly to Section 5 “UPS OPERATION”. To change any of the default settings proceed directly to Section 4.2 “Changing Default Settings”.

4.2 Changing Default Settings

Plug the input of the UPS into a two-pole, three-wire, grounded receptacle. Avoid using extension cords. If the mains voltage is within the acceptable range, the UPS will enter bypass mode. “BYPASS” will be displayed in the UPS status window on the LCD display.

LCD Display in Bypass Mode

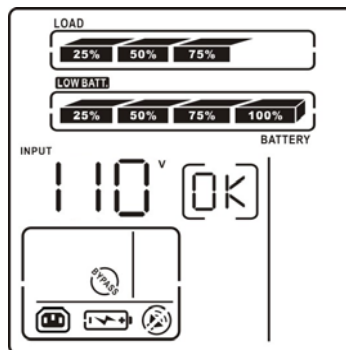

Rack Display

NOTE: The LCD will display the actual input voltage in the input/output and battery window.

1. Press and hold the “SELECT” button for at least five seconds to enter the UPS setting mode.

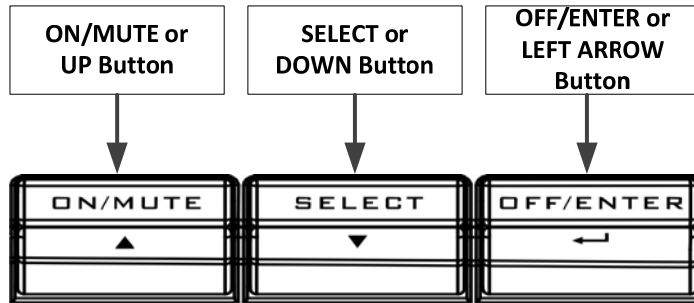

2. Press the “UP” or the “DOWN” button to scroll thru all of the parameters itemized as (01, 02, 03, 06, 07, 08, 09, 10 and 11).
3. When you see the item of the parameter that you want changed press the “LEFT ARROW” button. In the “Setting Operation” window on the LCD display the item will blink depending on the selected parameter.
4. Press the “UP” or the “DOWN” button to scroll thru all of the available settings for that parameter.
5. When you see the setting that you want for that parameter press the “LEFT ARROW” button to choose that setting.
6. To exit the UPS setting mode press the “UP” or “DOWN” button and scroll to the ESCAPE function (item 00).
7. Press the “LEFT ARROW” button.

4.2.1 Output Voltage Setting (Item 01)

Interface	Setting												
<p>The LCD interface shows a digital display with '110' and a 'V' symbol. Above the display are labels for 'LOAD', 'OUTPUT', and 'BATTERY'. There are also some graphical icons representing a battery and a plug.</p>	<p>The following output voltage can be chosen for on-line mode operation:</p> <table border="0"> <tr> <td>200 - 240 Volt Models</td> <td>100 - 120 Volt Models</td> </tr> <tr> <td>200: Output Voltage is 200VAC</td> <td>100: Output Voltage is 100VAC</td> </tr> <tr> <td>208: Output Voltage is 208VAC</td> <td>110: Output Voltage is 110VAC</td> </tr> <tr> <td>220: Output Voltage is 220VAC</td> <td>115: Output Voltage is 115VAC</td> </tr> <tr> <td>230: Output Voltage is 230VAC</td> <td>120: Output Voltage is 120VAC</td> </tr> <tr> <td>240: Output Voltage is 240VAC</td> <td></td> </tr> </table>	200 - 240 Volt Models	100 - 120 Volt Models	200: Output Voltage is 200VAC	100: Output Voltage is 100VAC	208: Output Voltage is 208VAC	110: Output Voltage is 110VAC	220: Output Voltage is 220VAC	115: Output Voltage is 115VAC	230: Output Voltage is 230VAC	120: Output Voltage is 120VAC	240: Output Voltage is 240VAC	
200 - 240 Volt Models	100 - 120 Volt Models												
200: Output Voltage is 200VAC	100: Output Voltage is 100VAC												
208: Output Voltage is 208VAC	110: Output Voltage is 110VAC												
220: Output Voltage is 220VAC	115: Output Voltage is 115VAC												
230: Output Voltage is 230VAC	120: Output Voltage is 120VAC												
240: Output Voltage is 240VAC													

4.2.2 Frequency Converter Enable/Disable (Item 02)

Interface	Setting
<p>The LCD interface shows a digital display with 'ENA' and '02'. Above the display are labels for 'LOAD' and 'BATTERY'. There are also some graphical icons representing a battery and a plug.</p>	<p>ENA: frequency converter mode is enabled. When the input frequency is at or between 40Hz to 70Hz the output frequency will be constant and equal to the value (50 Hz or 60Hz) chosen in section 4.2.3 and the output voltage will be constant and equal to the value chosen in section 4.2.1. The bypass will be disabled in this mode.</p> <p>DIS: converter mode is disabled. The output frequency is equal to the input frequency and the output voltage will be equal to the value chosen in section 4.2.1.</p>

4.2.3 Output Frequency Setting (Item 03)

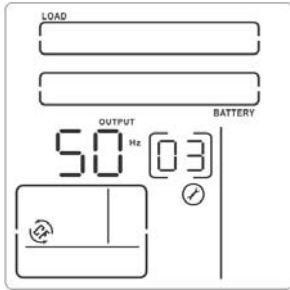
Interface	Setting
	<p>You may set the initial frequency on battery mode: 50: output frequency is 50Hz 60: output frequency is 60Hz</p> <p>If converter mode is enabled , the following output frequency can be chosen: 50: output frequency is 50Hz 60: output frequency is 60Hz</p>

4.2.4 Bypass Mode Enable /Disable when the UPS is off (Item 06)

Interface	Setting
	<p>ENA: Bypass mode is enabled when the UPS is turned off. When the UPS is first plugged in, it will enter bypass mode, or if the UPS is in on-line mode and then turned off , it will enter bypass mode.</p> <p>DIS: Bypass mode is disabled when the UPS is turned off. When the UPS is first plugged in, it will enter standby mode with no output, or if the UPS is in on-line mode and then turned off , it will enter standby mode with no output.</p>

4.2.5 Programmable Outlets Enable /Disable (Item 07)

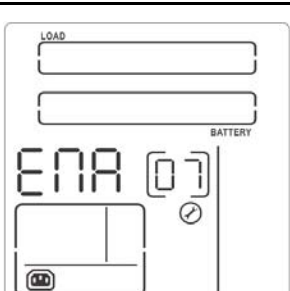
Interface	Setting
	<p>ENA: Programmable outlets are enabled. When the UPS goes to Battery mode the programmable outlets will supply power to the connected load for a duration equal to the timer setting in section 4.2.6 or until the battery becomes depleted, which ever occurs first.</p> <p>DIS: Programmable outlets are disabled. When the UPS goes to battery mode the programmable outlets will supply power to the connected load until the battery becomes depleted.</p>

4.2.6 Programmable Outlets Setting (Item 08)

Interface	Setting
	0-999: Backup time in minutes that programmable output receptacles will operate in battery mode.

4.2.7 LCD Display Direction Setting (Item 09)

Interface	Setting
	RAC: the LCD display is horizontal. TOE: the LCD display is vertical.

4.2.8 Acceptable Input Voltage Range Setting (Item 10)

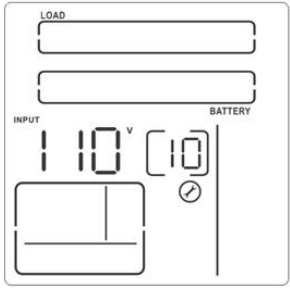
Interface	Setting	
	Display alternates between low and high voltage of the range. The following acceptable input voltage range may be chosen:	
	200 - 240 Volt Models	100 - 120 Volt Models
	170/240: 170-240 V Input Range	85/135 : 85-135 V Input Range
	160/260: 160-260 V Input Range	80/130: 80-130 V Input Range
	180/300: 180-300 V Input Range	55/150: 55-150 V Input Range

4.2.9 Number of External Battery Cabinets (Item 11)

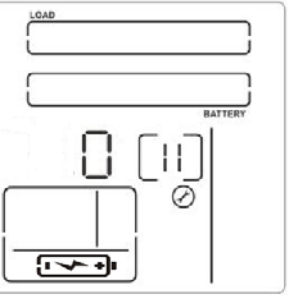
Interface	Setting
	The following number of external battery cabinets can be chosen: 0: No External Battery Cabinet. 1: One External Battery Cabinet. 2: Two External Battery Cabinets. 3: Three External Battery Cabinets. 4: Four External Battery Cabinets.

5. UPS Operation

5.1 UPS Input Connection

Plug the input of the UPS into a two-pole, three-wire, grounded receptacle. Avoid using extension cords.



ATTENTION: This UPS is supplied with standard power cords and receptacles suitable for use in your area of operation. It may be installed and operated by non-technical personnel.

If the mains voltage is within the acceptable range, and the bypass is enabled the UPS will enter bypass mode. “BYPASS” will be displayed in the UPS status window on the LCD display. See Section 5.1.1 “LCD Display in Bypass Mode”.

If instead the bypass is disabled, the UPS will enter standby mode. In this mode the UPS will not supply output power to the load. See Section 5.1.2 “LCD Display in Standby Mode”.

5.1.1 LCD Display in Bypass Mode

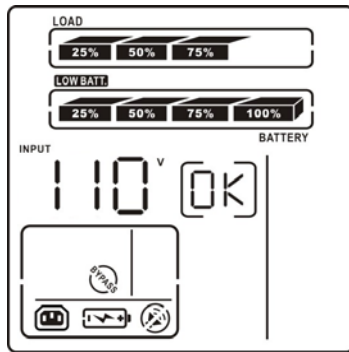

Rack Display

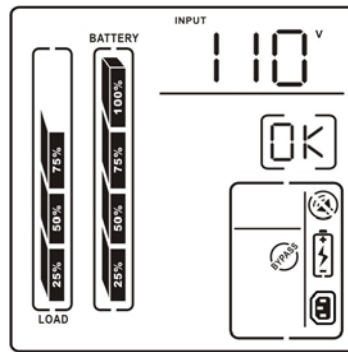

Tower Display

5.1.2 LCD Display in Standby Mode

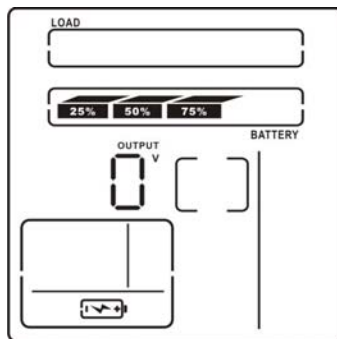

Rack Display

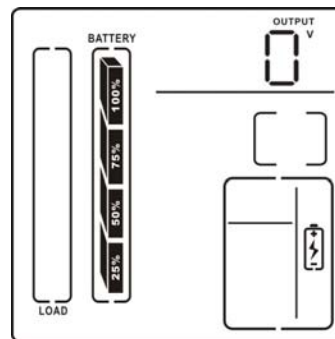

Tower Display

5.2 Turn on the UPS (Put the UPS in On-Line Mode)

When the input voltage is within the acceptable range press and hold the “ON/Mute” button for at least two seconds. A few seconds later the UPS will turn on and enter on-line mode. “ONLINE” will be displayed in the UPS status window on the LCD display. The UPS will provide pure and stable AC power to the output. The UPS will also charge the batteries.

5.2.1 LCD Display in On-Line Mode

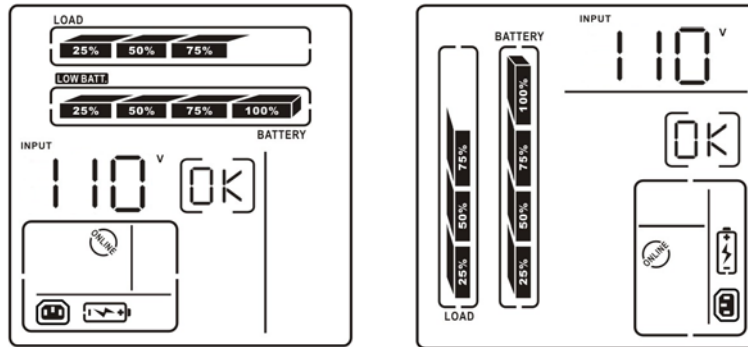

Rack Display

Tower Display

5.3 Connect Devices to the UPS

After the UPS has been turned on, devices (load) can now be connected to the UPS. For socket-type outputs, there are two kinds of outputs: programmable outlets and general purpose outlets. Connect non-critical devices to the programmable outlets and critical devices to the general outlets. During power failure, you may extend the backup time to critical devices by enabling the programmable outlets (see Sections 4.2.5 and 4.2.6).

- 1) With the UPS on-line switch on the load devices one by one. The LCD display panel will display the load level by 0-25%, 26-50%, 51-75% and 76-100%.
- 2) If the UPS is overloaded the audible alarm will beep twice every second and the LCD display panel will display “OVERLOAD”.
- 3) When the UPS is overloaded remove some load immediately.
- 4) When the UPS is in on-line mode, and the overload time exceeds the duration listed in the specification, the UPS will automatically transfer to bypass mode. At this time, if the bypass is enabled, the UPS will supply power to the load via bypass. If the bypass function is disabled, or the input voltage is not within the bypass acceptable range, the UPS will cutoff power to the load. After the overload is removed the UPS will return to on-line mode.
- 5) After repetitive overloads, the UPS will be locked in bypass mode. Remove excess loads from the UPS output. Then restart the UPS.

5.4 The UPS in Battery Mode

- 1) When the input voltage is not within the acceptable range or there is a mains failure the UPS will enter battery mode. The batteries will continue to provide an uninterrupted supply of energy to the load.
- 2) When the UPS is in battery mode the LCD display panel will display the battery level by 0-25%, 26-50%, 51-75% and 76-100% and the battery voltage. The audible alarm will beep according to the battery capacity. Normally, the audible alarm will beep once every four seconds. When the battery voltage drops to low battery voltage level, the audible alarm will beep once per second and the UPS will automatically shut down. At this time, users could switch off any non-critical loads to disable the shutdown alarm and prolong the backup time. If no more load can be removed at this time, then all loads should be shut down as soon as possible to protect the devices or to save data. Otherwise, there is a risk of data loss or load failure.
- 3) When the UPS is in battery mode, overloaded, and the overload time exceeds the duration listed in the specification, the UPS will enter a fault status. At this time, if the bypass is enabled, the UPS will supply power to the load via bypass. If the bypass function is disabled, or the input voltage is not within the bypass acceptable range, the UPS will cutoff power to the load.

5.4.1 LCD Display in Battery Mode

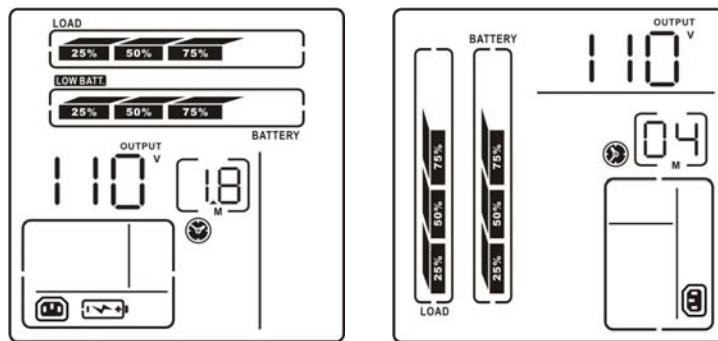

Rack Display

Tower Display

5.5 Turn Off the UPS

Press and hold the “OFF/ENTER “ button for at least two seconds.

At this time, if the bypass is enabled and if the mains voltage is within the acceptable range, the UPS will enter bypass mode supplying power to the loads via bypass. The UPS will also charge the batteries. “BYPASS” will be displayed in the UPS status window on the LCD display. See Section 5.1.1 “LCD Display in Bypass Mode”.

If instead the bypass is disabled, the UPS will enter standby mode. In this mode the UPS will not supply power to the load. The UPS will also charge the batteries. See Section 5.1.2 “LCD Display in Standby Mode”.

6. INTERFACES

The UPS's are equipped with a serial interface COM 3, USB and a interface slot COM. These interfaces can be used for :

1. Direct communication between UPS and a workstation/server.
2. Integration of the UPS as client into a network with centralized monitoring via a Manage UPSNET SNMP adaptor in the slot COM.
3. Transfer of operational states to external alarm systems via voltage-free contacts: with interface card SIC in the slot COM.

The necessary communication software packages and interface cables are available as options.

6.1 Serial Interface COM 3

The 9-pole SUB-D connector (pin contacts) contains RS232 compatible signals.

NOTE: The interface COM RS232 is electrically isolated from primary UPS circuits.

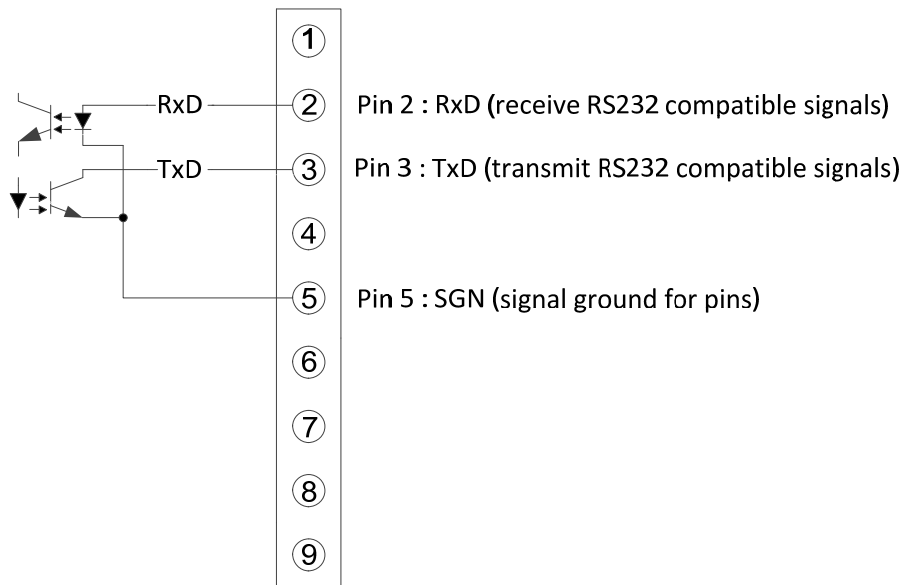

6.2 Interface Slot COM

The interface slot COM can be fitted with various optional interface cards. Interface cards include:

- SNMP dapter (Manage UPSNET) for Connecting the Device to a Network
- Isolated Contacts Card

Refer to the installation guide supplied with the optional interface card.

7. Emergency Power Off (EPO)

Disable and Enable the EPO Function

Keep Pin 1 and Pin 2 closed (shorted) for UPS normal operation. To activate the EPO function, remove the wire between Pin 1 and Pin 2.

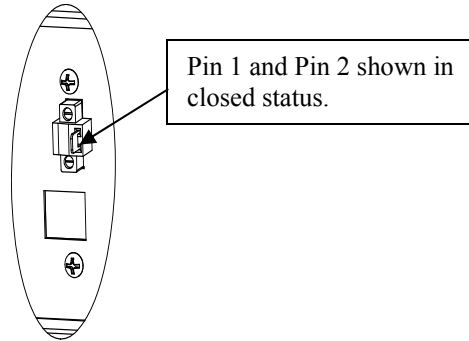

8. Maintenance

8.1 Cleaning

1. Do not use scouring powder or plastic dissolving solutions to clean the UPS.
2. Do not allow liquid to get inside the UPS.
3. Make sure that the air vents on the UPS are not obstructed. Remove dust from the air vents with a vacuum cleaner.
4. Clean the outside of the UPS housing by wiping with a dry or slightly damp cloth.

8.2 UPS Storage

1. For extended storage at ambient temperatures $< 77^{\circ}\text{F}$ (25°C), the batteries should be charged for five hours once every four months. At higher storage temperatures it is advised that this period be reduced to two months.
2. To charge the batteries, connect the UPS to an appropriate power source and allow the batteries to charge for about five hours. After charging, note the date recharging was performed on the UPS packaging.

8.3 Battery Testing

1. The UPS does not require maintenance by the user; however, the battery should be checked periodically.

.4 Replacing Batteries

The UPS does not require maintenance by the user, however, battery maintenance is recommended in accordance with IEEE Recommended Practice for Maintenance, Testing and Replacement of Valve-Regulated Lead-Acid (VRLA) Batteries for Stationary Applications (IEEE Std 1188-1996). When the batteries expire, trained battery service personnel must replace them. A certified disposal/recycling company should carry out disposal/recycling of the UPS and/or batteries. Exhausted rechargeable batteries are classified as “harmful toxic waste” and as such the law demands that they be disposed of/recycled by an authorized recycling center. The manufacturer’s service center is fully equipped to deal with such batteries, in accordance with the law and with the greatest respect for the environment. Contact Technical Support to arrange for maintenance and or battery replacement.

The typical battery life cycle is three to five years, at an ambient temperature of 77°F (25°C), but is also dependent on the frequency and duration of mains failure.

Once the battery has reached the end of its useful life, follow the procedure for battery replacement later in this section.

After the batteries have been replaced, a certified disposal/recycling company should carry out disposal/recycling of the used batteries.

Exhausted rechargeable batteries are classified as “harmful toxic waste” and as such the law demands that they be disposed of/recycled by an authorized recycling center.

The manufacturer’s service center is fully equipped to deal with such batteries, in accordance with the law and with the greatest respect for the environment. Contact technical support to arrange for maintenance and/or battery replacement. See page 1 for contact information.



CAUTION:

- Servicing of batteries should be performed or supervised by personell knowledgeable about batteries and the required precautions.
- The batteries installed in the UPS and in the external battery cabinets contain electrolyte. Under normal conditions the containers are dry. A damaged battery may leak electrolyte that can be dangerous in contact with skin and cause irritation to the eyes. Should this happen, wash the affected part with copious amounts of water and seek immediate medical attention.
- When replacing batteries, replace with the same type and number of batteries or battery packs.
- Do not dispose of batteries in a fire. The batteries may explode.
- Do not open or damage the battery cases. Released electrolyte is harmful to the skin and eyes and may be toxic.
- A battery can present a risk of electrical shock and high short-circuit current. The following precautions should be observed when working on batteries:
 - Remove watches, rings or other metal objects.
 - Use tools with insulated handles. Do not lay tools or metal parts on top of batteries.
 - Wear rubber gloves and boots.

This UPS is equipped with internal batteries. The user can replace the batteries without shutting down the UPS or connected loads (hot-swappable battery design). Replacement is a safe procedure - isolated from electrical hazards.



ATTENTION: Consider all warnings, cautions, and notes before replacing batteries.

- The load attached to the UPS will not be protected against loss of input power during this procedure.
- Battery pack is heavy. Use two hands when removing pack from unit.
- The batter packs for the ACDEF3000-XX are not user replaceable. Contact technical support to arrange for maintenance and battery replacement.

To replace internal batteries:

1. Place the UPS in bypass mode.
2. Place fingers on the left hand side of the front cover and pull forward until the left side of the front cover “snaps” out of position. Remove the left side of the front cover and place it in a safe place. Refer to the figure directly below :

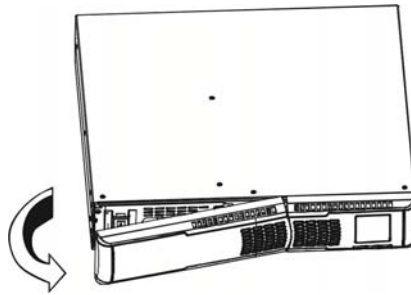

3. Remove the four screws securing the battery retention plate to the UPS enclosure. Set the battery retention plate and retaining screws aside for later reuse. Cut the tie holding the two halves of the battery pack connector. Disconnect the battery connectors. Refer to the figures directly below :

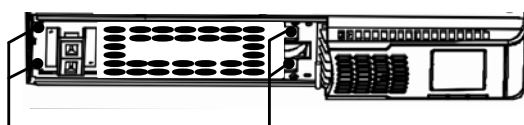

Battery Retention Plate Screws

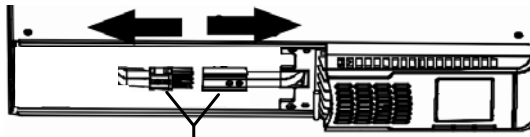

Battery pack connector

4. Pull out the battery pack. Refer to the figure directly below :

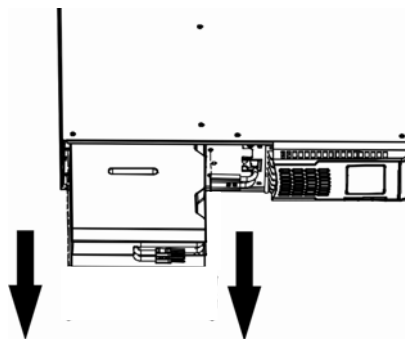

5. Slide in replacement battery pack. Refer to the figure directly below :

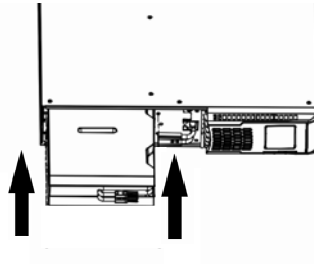

6. Reconnect the battery connectors. Use the tie wrap supplied with the replacement battery kit to secure the two halves of the battery connector together. Re-install the battery retention plate using the screws removed in step 3. Refer to the figures directly below :

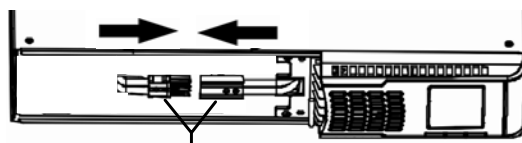

Battery pack connector

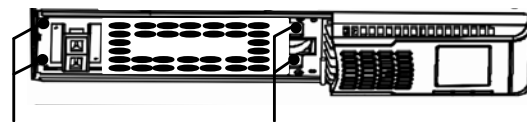

Battery Retention Plate Screws

7. Align left plastic front cover and snap into place. Refer to the figure directly below :

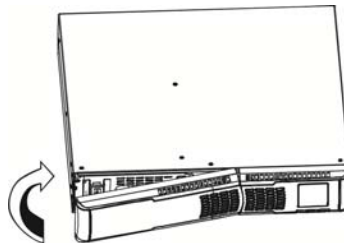

9. Carefully pack used battery pack and send to authorized recycle center.









Do not discard waste electrical or electronic equipment (WEEE) in the trash. For proper disposal, contact your local recycling/reuse or hazardous waste center.

9. Troubleshooting

If the UPS system does not function properly, please resolve the problem by referring to the table below and on the following page.

9.1 Troubleshooting Table

Symptom	Possible cause	Remedy
No warning or fault indication and no alarm even though the mains is normal.	The AC input power cord may not be firmly connected to the input of the UPS or to the mains.	Confirm that the AC input power cord is firmly connected to the input of the UPS and also to the mains.
	The AC input is connected to the UPS output.	Plug the AC input power cord firmly to the AC input.
The icon  is flashing and the warning code EP appears on the LCD display. The alarm beeps once every second.	EPO function has been activated.	Set pin 1 and pin 2 on the EPO connector in a closed (shorted) position to disable the EPO function.
The icon  is flashing and the warning code S.F appears on the LCD display. The alarm beeps once every second.	The Line and neutral conductors of the UPS input are reversed.	Rotate the mains power socket by 180° and then reconnect to the UPS system.
The icon  and  are flashing and the warning code NC appears on the LCD display. The alarm beeps once every second.	The external or the internal battery is not connected properly.	Check if all batteries are properly connected.
Fault code is shown as 27 and the icon  appears on the LCD display. The alarm beeps continuously.	The battery voltage is too high or the charger may be at fault.	Contact your dealer.
Fault code is shown as 28 and the icon  appears on the LCD display. The alarm beeps continuously.	The battery voltage is too low or the charger may be at fault.	Contact your dealer.
The icon  and OVERLOAD are flashing and the warning code OL appears on the LCD display. The alarm beeps twice every second.	UPS is overloaded.	Remove excess loads from UPS output.
	UPS is overloaded. Devices connected to the UPS are fed directly by the electrical network via the bypass.	Remove excess loads from UPS output.
	After repetitive overloads, the UPS is locked in the bypass mode. Connected devices are fed directly by the mains.	Remove excess loads from the UPS output. Then shut down the UPS and restart it.

Symptom	Possible cause	Remedy
Fault code is shown as 43 and the icon OVER LOAD appears on the LCD display. The alarm beeps continuously.	The UPS shut down automatically because of an overload on the output of the UPS.	Remove excess loads from UPS output and restart it.
Fault code is shown as 14 and the icon SHORT appears on the LCD display. The alarm beeps continuously.	The UPS shut down automatically because of a short circuit on the output of the UPS.	Check the output wiring and connected devices for a short circuit. Remove the short circuit.
Fault code is shown as 01, 02, 03, 04, 11, 12, 13 and 41 on the LCD display and the alarm beeps continuously.	A UPS internal fault has occurred. There are two possible results: 1. The load is still supplied, but directly from AC power via bypass. 2. The load is no longer supplied by power.	Contact your dealer.
Battery backup time is shorter than the specified value.	Batteries are not fully charged.	Charge the batteries for at least five hours and then check capacity. If the problem still persists, consult your dealer.
	Batteries are defective.	Contact your dealer to replace the battery.
Fault code is shown as 05 on the LCD display. At the same time, the alarm is beeping continuously and the output of the UPS is cut off.	A UPS internal fault has occurred and the BUS is short circuited.	Consult your dealer. If power is supplied again to the UPS before the UPS is repaired then the DC/DC mosfet will be damaged.













9.2 Audible Alarm

Battery Mode	Alarms Beeps Once Every Four Seconds
Low Battery	Alarm Beeps Once Every Second
Overload	Alarm Beeps Twice Every Second
Fault	Alarm Beeps Continuously

9.3 LCD Display Abbreviation Index

Abbreviation	Display Content	Meaning
ENA	ENA	Enable
DIS	DIS	Disable
ESC	ESC	Escape
RAC	RAC	Rack Display
TOE	TOE	Tower Display
B.L	b.L	Low Battery
O.L	OL	Overload
N.C	NC	Battery is Not Connected
O.C	OC	Overcharge
SF	SF	Site Fault
E.P	EP	EPO
T.P	TP	Over Temperature
C.H	CH	Charger Failure
B.B	b.b	Battery Fault
F.U	F.U	Frequency is Unstable in Bypass Mode
B.V	b.V	Input Voltage is Out of Bypass Range
E.E	E.E	EEPROM Error

9.4 Warning Indicators

Warning	Icon (flashing)	Code	Alarm
Low Battery		b.L	Beeps Once Every Second
Overload		o.L	Beeps Twice Every Second
Battery is Not Connected		n.C	Beeps Once Every Second
Overcharge		o.C	Beeps Once Every Second
Site Wiring Fault		S.F	Beeps Once Every Second
EPO Enable		E.P	Beeps Once Every Second
Over Temperature		E.P	Beeps Once Every Second
Charger Failure		C.H	Beeps Once Every Second
Battery Fault		b.b	Beeps Once Every Second
Bypass Out Range		b.U	Beeps Once Every Second
Bypass Frequency Unstable		F.U	Beeps Once Every Second
EEPROM Error		E.E	Beeps Once Every Second

9.5 UPS Fault

When there is a fault with the UPS the fault icon flashes on the LCD display. A fault code will also be displayed directly below the flashing fault icon. When a fault occurs no output power is supplied from the UPS.

9.5.1 LCD Display in Fault Mode

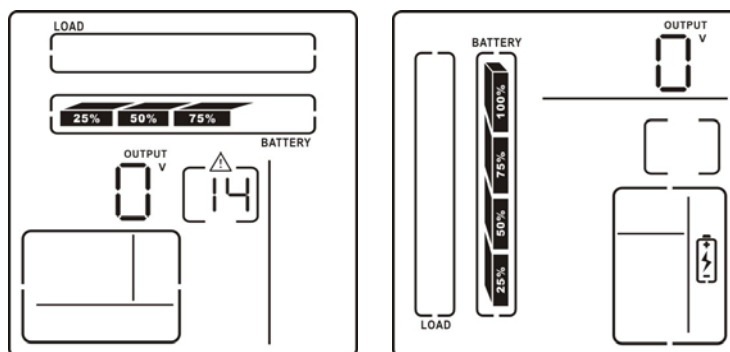

Rack Display

Tower Display

9.5.2 Fault Reference Code

Fault Event	Fault Code	Icon	Fault event	Fault Code	Icon
Bus Start Fail	01	x	Low Inverter Voltage	13	x
Bus Over	02	x	Inverter Output Short	14	SHORT
Bus Under	03	x	Battery Voltage Too High	27	x
Bus Unbalance	04	x	Battery Voltage Too Low	28	
Bus Short Circuited	05	x	Over Temperature	41	x
Inverter Soft Start Fail	11	x	Overload	43	OVER LOAD
High Inverter Voltage	12	x			

10. APPENDIX A: SPECIFICATIONS

10.1 SINERGY III UPS (100 - 120 Volt UPS's) Specifications



SPECIFICATIONS

Sinergy III Series UPS
700 VA Low Voltage

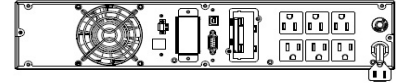
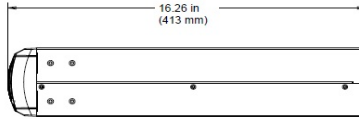
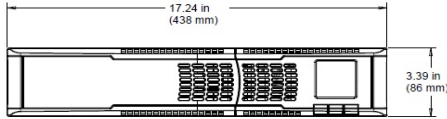

Model	ACDEF700-11
Part Number	17071-01R
Type	Sinergy III
Power Rating	700 VA / 630 W
Topology	On-Line Double Conversion
Heat Dissipation (BTU/Hour)	409 at 100% Load
Input Voltage (Nominal) Range	100-120 VAC 90-150 VAC
Input Frequency	50/60 Hz ±4 (Auto Sense on Start-Up)
Input Power Factor	>0.95
Input Current THD	<9.0%
Efficiency	>84.0%
Output Voltage	120 VAC (Default) 100/110/115 VAC (Selectable)
Output Current	5.8 A (Default) 7.0/6.4/6.1 A (Selectable)
Voltage Regulation	±1.0%
Overload Online Mode	100-105%: Continuous; Warning Only 105-130%: 2 Minutes 130-200%: 10 Seconds >200%: 250 Milliseconds
Overload Battery Mode	100-105%: Continuous; Warning Only 105-130%: 10 Seconds >130%: 250 Milliseconds
Overload Bypass Mode	100-110%: Continuous; Warning Only 110-120%: 30 Minutes 120-130%: 10 Minutes >130%: 1 Minute
Battery Voltage (Float / Nominal)	27.4/24.0 VDC
Charger Current	1.0 A
Backup Time (Full Load)	>5.7 Minutes
Communications Interface	USB / RS-232
Shipping Weight	37.0 lbs. / 16.8 kg.

SPECIFICATIONS CONT.

SINERGY III UPS (100 - 120 Volt UPS's) specifications cont.



SPECIFICATIONS

Front Panel Controls

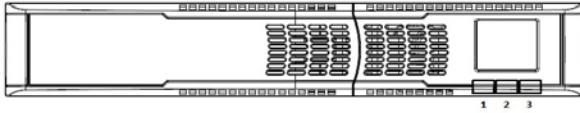

1. ON / MUTE - UP KEY (Previous Selection)
2. SELECT - DOWN KEY (Next Selection)
3. OFF / ENTER - CONFIRM KEY

Front Panel Display

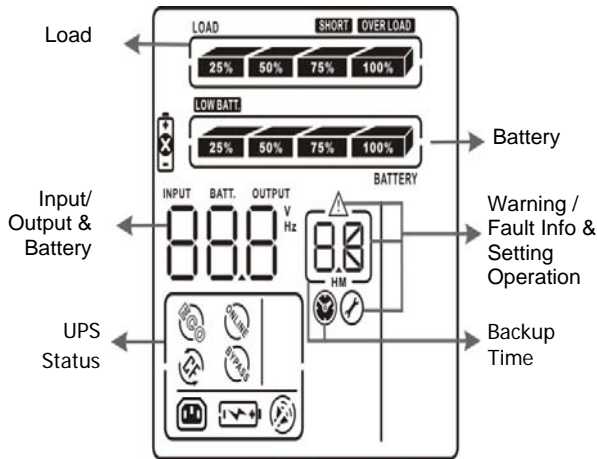

Rear Panel Information and Controls

- 6 Foot Line Cord with NEMA 5-15P
- (3) NEMA 5-15R Direct
- (3) NEMA 5-15R Programmable
- USB & RS-232 Communication
- SNMP Adapter (Optional)
- Internal Relay Contact Card (Optional)
- Circuit Breaker

Internal Batteries

- User Hot-Swappable (See Instruction Manual)
- Type - 12 V, 8.5 AH
- Quantity - 2 Batteries
- Recharge time - 12 Hours to 100%

Environmental

- Temperature: 0 to 40°C (32 to 104°F) Operating
-20 to 50°C (-40 to 122°F) Shipment, Storage
- Humidity: <90% Non-Condensing (Operating, Shipment, Storage)
- Altitude: <1000m Operating, No De-Rating
>1000m De-Rate Output 1% per 100m

Safety Agency and EMC Compliance

All units are listed by UL, and marked with the UL/cUL marking.

Product Listings

- UL1778
- cUL to CSA22.2 No.107.1

Product Compliances

- FCC Part 15J Class A
- IEC61000-4-2, Electrostatic Discharge
- IEC61000-4-3, Radiated Electromagnetic Field Immunity
- IEC61000-4-4, Electrical Fast Transient/Burst Immunity
- IEC61000-4-5, Surge Immunity
- IEC61000-4-6, CS
- IEC61000-4-8, Power Frequency Magnetic Field
- IEC61000-2-2, Low Frequency Signal
- RoHS

Warranty/Support: Sinergy III Series products (hereafter referred to as "Product") are warranted to be free from defects in material and workmanship for **two (2) years** from date of shipment from POWERVAR, on the chassis & electronic components and **two (2) years** from date of shipment from POWERVAR on the batteries. This warranty is limited to repairing, replacing, or refurbishing, at POWERVAR's option, any defective component, circuit board or module within the Product. This warranty will include, at POWERVAR's sole discretion, on-site service or POWERVAR depot service. See the Limitations of Warranty section below for additional limitations & exclusions.

Battery Life Disclaimer: POWERVAR's standard battery warranty applies only to UPS and UPM products which are continuously connected to AC mains power, except during utility power outages. Products which are regularly and intentionally disconnected from AC mains power will experience battery discharge/charge cycles potentially far more numerous than those for which the battery was designed. As a result, products used in such applications will experience substantially reduced battery life. For that reason, POWERVAR's standard battery warranty does not apply for applications in which the UPS or UPM product is regularly and intentionally disconnected from AC mains power. POWERVAR UPS and UPM products used in such applications shall receive a 90 day warranty on batteries.

POWERVAR, Inc. - 1450 Lakeside Drive, Waukegan, IL 60085

POWERVAR, Ltd. - Unit 5 Birch, Kembrey Park, Swindon, Wiltshire, UK SN2 8UU

SPECIFICATIONS CONT.

SINERGY III UPS (100 - 120 Volt UPS's) specifications cont.



SPECIFICATIONS

Sinergy III Series UPS
1000 VA Low Voltage

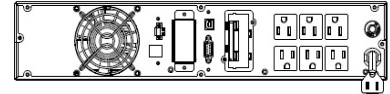
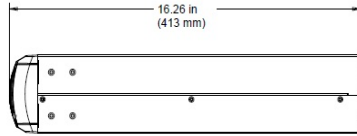
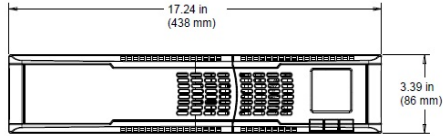

Model	ACDEF1000-11
Part Number	17101-01R
Type	Sinergy III
Power Rating	1000 VA / 900 W
Topology	On-Line Double Conversion
Heat Dissipation (BTU/Hour)	520 at 100% Load
Input Voltage (Nominal) Range	100-120 VAC 90-150 VAC
Input Frequency	50/60 Hz \pm 4 (Auto Sense on Start-Up)
Input Power Factor	>0.95
Input Current THD	<9.0%
Efficiency	>84.0%
Output Voltage	120 VAC (Default) 100/110/115 VAC (Selectable)
Output Current	8.3 A (Default) 10.0/9.1/8.7 A (Selectable)
Voltage Regulation	\pm 1.0%
Overload Online Mode	100-105%: Continuous; Warning Only 105-130%: 2 Minutes 130-200%: 10 Seconds >200%: 250 Milliseconds
Overload Battery Mode	100-105%: Continuous; Warning Only 105-130%: 10 Seconds >130%: 250 Milliseconds
Overload Bypass Mode	100-110%: Continuous; Warning Only 110-120%: 30 Minutes 120-130%: 10 Minutes >130%: 1 Minute
Battery Voltage (Float / Nominal)	27.4/24.0 VDC
Charger Current	1.0 A
Backup Time (Full Load)	>3.5 Minutes
Communications Interface	USB / RS-232
Shipping Weight	37.0 lbs. / 16.8 kg.

SPECIFICATIONS CONT.

SINERGY III UPS (100 - 120 Volt UPS's) specifications cont.



SPECIFICATIONS

Front Panel Controls

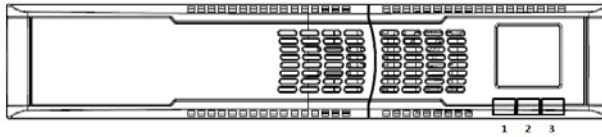

1. ON / MUTE - UP KEY (Previous Selection)
2. SELECT - DOWN KEY (Next Selection)
3. OFF / ENTER - CONFIRM KEY

Front Panel Display

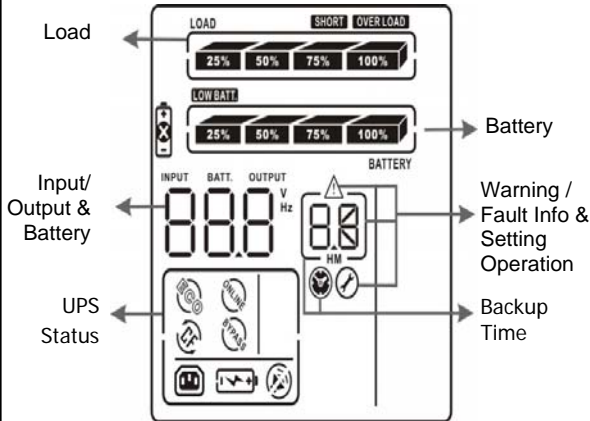

Rear Panel Information and Controls

- 6 Foot Line Cord with NEMA 5-15P
- (3) NEMA 5-15R Direct
- (3) NEMA 5-15R Programmable
- USB & RS-232 Communication
- SNMP Adapter (Optional)
- Internal Relay Contact Card (Optional)
- Circuit Breaker

Internal Batteries

- User Hot-Swappable (See Instruction Manual)
- Type - 12 V, 8.5 AH
- Quantity - 2 Batteries
- Recharge time - 12 Hours to 100%

Environmental

- Temperature: 0 to 40°C (32 to 104°F) Operating
-20 to 50°C (-40 to 122°F) Shipment, Storage
- Humidity: <90% Non-Condensing (Operating, Shipment, Storage)
- Altitude: <1000m Operating, No De-Rating
>1000m De-Rate Output 1% per 100m

Safety Agency and EMC Compliance

All units are listed by UL, and marked with the UL/cUL marking.

Product Listings

- UL1778
- cUL to CSA22.2 No.107.1

Product Compliances

- FCC Part 15J Class A
- IEC61000-4-2, Electrostatic Discharge
- IEC61000-4-3, Radiated Electromagnetic Field Immunity
- IEC61000-4-4, Electrical Fast Transient/Burst Immunity
- IEC61000-4-5, Surge Immunity
- IEC61000-4-6, CS
- IEC61000-4-8, Power Frequency Magnetic Field
- IEC61000-2-2, Low Frequency Signal
- RoHS

Warranty/Support: Sinergy III Series products (hereafter referred to as "Product") are warranted to be free from defects in material and workmanship for **two (2) years** from date of shipment from POWERVAR, on the chassis & electronic components and **two (2) years** from date of shipment from POWERVAR on the batteries. This warranty is limited to repairing, replacing, or refurbishing, at POWERVAR's option, any defective component, circuit board or module within the Product. This warranty will include, at POWERVAR's sole discretion, on-site service or POWERVAR depot service. See the Limitations of Warranty section below for additional limitations & exclusions.

Battery Life Disclaimer: POWERVAR's standard battery warranty applies only to UPS and UPM products which are continuously connected to AC mains power, except during utility power outages. Products which are regularly and intentionally disconnected from AC mains power will experience battery discharge/charge cycles potentially far more numerous than those for which the battery was designed. As a result, products used in such applications will experience substantially reduced battery life. For that reason, POWERVAR's standard battery warranty does not apply for applications in which the UPS or UPM product is regularly and intentionally disconnected from AC mains power. POWERVAR UPS and UPM products used in such applications shall receive a 90 day warranty on batteries.

POWERVAR, Inc. - 1450 Lakeside Drive, Waukegan, IL 60085

POWERVAR, Ltd. - Unit 5 Birch, Kembrey Park, Swindon, Wiltshire, UK SN2 8UU

SPECIFICATIONS CONT.

SINERGY III UPS (100 - 120 Volt UPS's) specifications cont.



SPECIFICATIONS

Sinergy III Series UPS
1500 VA Low Voltage

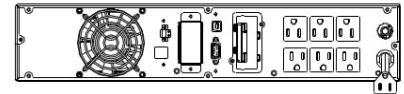
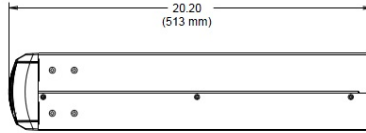
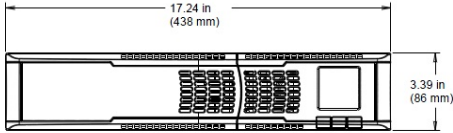

Model Part Number	ACDEF1500-11 17151-01R / 17151-02R
Type	Sinergy III
Power Rating	1500 VA / 1350 W
Topology	On-Line Double Conversion
Heat Dissipation (BTU/Hour)	877 at 100% Load
Input Voltage (Nominal) Range	100-120 VAC 105-150 VAC
Input Frequency	50/60 Hz ±4 (Auto Sense on Start-Up)
Input Power Factor	>0.95
Input Current THD	<9.0%
Efficiency	>84.0%
Output Voltage	120 VAC (Default) 100/110/115 VAC (Selectable)
Output Current	12.5 A (Default) 15.0/13.6/13.0 A (Selectable)
Voltage Regulation	±1.0%
Overload Online Mode	100-105%: Continuous; Warning Only 105-130%: 2 Minutes 130-200%: 10 Seconds >200%: 250 Milliseconds
Overload Battery Mode	100-105%: Continuous; Warning Only 105-130%: 10 Seconds >130%: 250 Milliseconds
Overload Bypass Mode	100-110%: Continuous; Warning Only 110-120%: 30 Minutes 120-130%: 10 Minutes >130%: 1 Minute
Battery Voltage (Float / Nominal)	41.1/36.0 VDC
Charger Current	1.0 A
Backup Time (Full Load)	>3.5 Minutes
Communications Interface	USB / RS-232
Shipping Weight	51.0 lbs. / 23.2 kg.

SPECIFICATIONS CONT.

SINERGY III UPS (100 - 120 Volt UPS's) specifications cont.



SPECIFICATIONS

Front Panel Controls

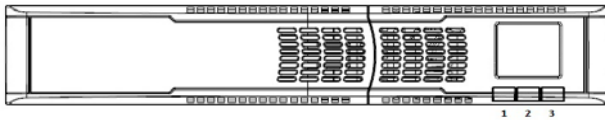

1. ON / MUTE - UP KEY (Previous Selection)
2. SELECT - DOWN KEY (Next Selection)
3. OFF / ENTER - CONFIRM KEY

Front Panel Display

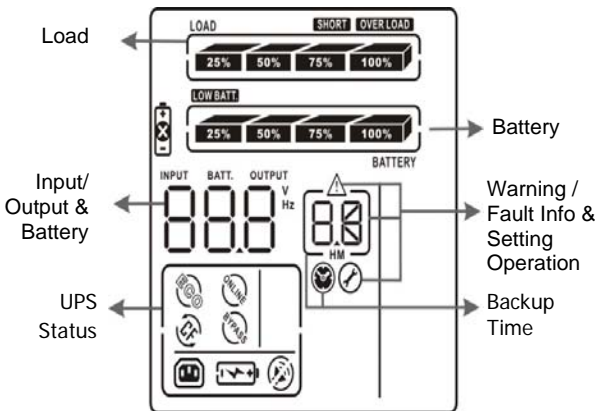

Rear Panel Information and Controls

- 6 Foot Line Cord with NEMA 5-15P (**17151-01R Only**)
- 6 Foot Line Cord with NEMA 5-20P (**17151-02R Only**)
- (3) NEMA 5-15R Direct
- (3) NEMA 5-15R Programmable
- USB & RS-232 Communication
- SNMP Adapter (Optional)
- Internal Relay Contact Card (Optional)
- Circuit Breaker

Internal Batteries

- User Hot-Swappable (See Instruction Manual)
- Type - 12 V, 8.5 AH
- Quantity - 3 Batteries
- Recharge time - 12 Hours to 100%

Environmental

- Temperature: 0 to 40°C (32 to 104°F) Operating
-20 to 50°C (-40 to 122°F) Shipment, Storage
- Humidity: <90% Non-Condensing (Operating, Shipment, Storage)
- Altitude: <1000m Operating, No De-Rating
>1000m De-Rate Output 1% per 100m

Safety Agency and EMC Compliance

All units are listed by UL, and marked with the UL/cUL marking.

Product Listings

- UL1778
- cUL to CSA22.2 No.107.1

Product Compliances

- FCC Part 15J Class A
- IEC61000-4-2, Electrostatic Discharge
- IEC61000-4-3, Radiated Electromagnetic Field Immunity
- IEC61000-4-4, Electrical Fast Transient/Burst Immunity
- IEC61000-4-5, Surge Immunity
- IEC61000-4-6, CS
- IEC61000-4-8, Power Frequency Magnetic Field
- IEC61000-2-2, Low Frequency Signal
- RoHS

Warranty/Support: Sinergy III Series products (hereafter referred to as "Product") are warranted to be free from defects in material and workmanship for **two (2) years** from date of shipment from POWERVAR, on the chassis & electronic components and **two (2) years** from date of shipment from POWERVAR on the batteries. This warranty is limited to repairing, replacing, or refurbishing, at POWERVAR's option, any defective component, circuit board or module within the Product. This warranty will include, at POWERVAR's sole discretion, on-site service or POWERVAR depot service. See the Limitations of Warranty section below for additional limitations & exclusions.

Battery Life Disclaimer: POWERVAR's standard battery warranty applies only to UPS and UPM products which are continuously connected to AC mains power, except during utility power outages. Products which are regularly and intentionally disconnected from AC mains power will experience battery discharge/charge cycles potentially far more numerous than those for which the battery was designed. As a result, products used in such applications will experience substantially reduced battery life. For that reason, POWERVAR's standard battery warranty does not apply for applications in which the UPS or UPM product is regularly and intentionally disconnected from AC mains power. POWERVAR UPS and UPM products used in such applications shall receive a 90 day warranty on batteries.

POWERVAR, Inc. - 1450 Lakeside Drive, Waukegan, IL 60085

POWERVAR, Ltd. - Unit 5 Birch, Kembrey Park, Swindon, Wiltshire, UK SN2 8UU

SPECIFICATIONS CONT.

SINERGY III UPS (100 - 120 Volt UPS's) specifications cont.



SPECIFICATIONS

Sinergy III Series UPS
2000 VA Low Voltage

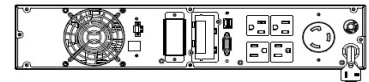
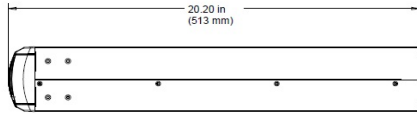
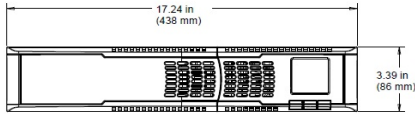

Model Part Number	ACDEF2000-11 17201-01R / 17201-02R / 17201-03R
Type	Sinergy III
Power Rating	2000 VA / 1800 W
Topology	On-Line Double Conversion
Heat Dissipation (BTU/Hour)	1171 at 100% Load
Input Voltage (Nominal) Range	100-120 VAC 105-150 VAC
Input Frequency	50/60 Hz \pm 4 (Auto Sense on Start-Up)
Input Power Factor	>0.95
Input Current THD	<9.0%
Efficiency	>84.0%
Output Voltage	120 VAC (Default) 100/110/115 VAC (Selectable)
Output Current	16.7 A (Default) 20.0/18.2/17.4 A (Selectable)
Voltage Regulation	\pm 1.0%
Overload Online Mode	100-105%: Continuous; Warning Only 105-130%: 2 Minutes 130-200%: 10 Seconds >200%: 250 Milliseconds
Overload Battery Mode	100-105%: Continuous; Warning Only 105-130%: 10 Seconds >130%: 250 Milliseconds
Overload Bypass Mode	100-110%: Continuous; Warning Only 110-120%: 30 Minutes 120-130%: 10 Minutes >130%: 1 Minute
Battery Voltage (Float / Nominal)	54.7/48.0 VDC
Charger Current	1.0 A
Backup Time (Full Load)	>3.6 Minutes
Communications Interface	USB / RS-232
Shipping Weight	58.0 lbs. / 26.4 kg.

SPECIFICATIONS CONT.

SINERGY III UPS (100 - 120 Volt UPS's) specifications cont.



SPECIFICATIONS

Front Panel Controls

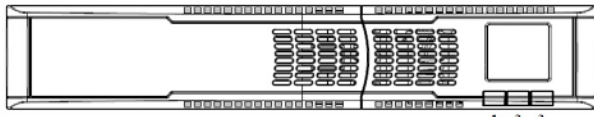

1. ON / MUTE - UP KEY (Previous Selection)
2. SELECT - DOWN KEY (Next Selection)
3. OFF / ENTER - CONFIRM KEY

Front Panel Display

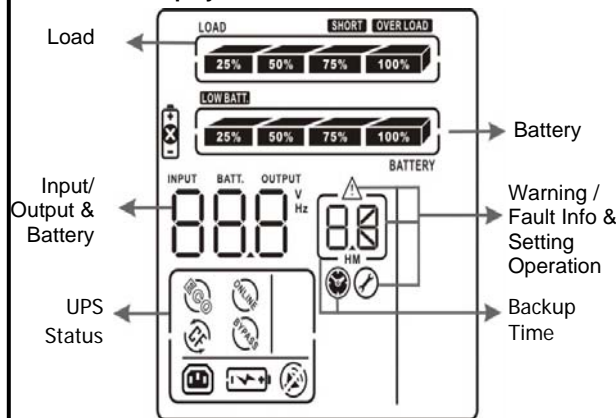

Rear Panel Information and Controls

- 6 Foot Line Cord with NEMA 5-20P (17201-01R Only, 1600 W Capability)
- 6 Foot Line Cord with NEMA L5-20P (17201-02R Only, 1600 W Capability)
- 6 Foot Line Cord with NEMA L5-30P (17201-03R Only, 1800 W Capability)
- (2) NEMA 5-20R
- (1) NEMA L5-20R Direct
- (2) NEMA 5-15R Programmable
- USB & RS-232 Communication
- SNMP Adapter (Optional)
- Internal Relay Contact Card (Optional)
- Circuit Breaker

Internal Batteries

- User Hot-Swappable (See Instruction Manual)
- Type - 12 V, 8.5 AH
- Quantity - 4 Batteries
- Recharge time - 12 Hours to 100%

Environmental

- Temperature: 0 to 40°C (32 to 104°F) Operating
-20 to 50°C (-40 to 122°F) Shipment, Storage
- Humidity: <90% Non-Condensing (Operating, Shipment, Storage)
- Altitude: <1000m Operating, No De-Rating
>1000m De-Rate Output 1% per 100m

Safety Agency and EMC Compliance

All units are listed by UL, and marked with the UL/cUL marking.

Product Listings

- UL1778
- cUL to CSA22.2 No.107.1

Products Compliances

- FCC Part 15J Class A
- IEC61000-4-2, Electrostatic Discharge
- IEC61000-4-3, Radiated Electromagnetic Field Immunity
- IEC61000-4-4, Electrical Fast Transient/Burst Immunity
- IEC61000-4-5, Surge Immunity
- IEC61000-4-6, CS
- IEC61000-4-8, Power Frequency Magnetic Field
- IEC61000-2-2, Low Frequency Signal
- RoHS

Warranty/Support: Sinergy III Series products (hereafter referred to as "Product") are warranted to be free from defects in material and workmanship for **two (2) years** from date of shipment from POWERVAR, on the chassis & electronic components and **two (2) years** from date of shipment from POWERVAR on the batteries. This warranty is limited to repairing, replacing, or refurbishing, at POWERVAR's option, any defective component, circuit board or module within the Product. This warranty will include, at POWERVAR's sole discretion, on-site service or POWERVAR depot service. See the Limitations of Warranty section below for additional limitations & exclusions.

Battery Life Disclaimer: POWERVAR's standard battery warranty applies only to UPS and UPM products which are continuously connected to AC mains power, except during utility power outages. Products which are regularly and intentionally disconnected from AC mains power will experience battery discharge/charge cycles potentially far more numerous than those for which the battery was designed. As a result, products used in such applications will experience substantially reduced battery life. For that reason, POWERVAR's standard battery warranty does not apply for applications in which the UPS or UPM product is regularly and intentionally disconnected from AC mains power. POWERVAR UPS and UPM products used in such applications shall receive a 90 day warranty on batteries.

POWERVAR, Inc. - 1450 Lakeside Drive, Waukegan, IL 60085

POWERVAR, Ltd. - Unit 5 Birch, Kembrey Park, Swindon, Wiltshire, UK SN2 8UU

SPECIFICATIONS CONT.

SINERGY III UPS (100 - 120 Volt UPS's) specifications cont.



SPECIFICATIONS

Sinergy III Series UPS
3000 VA Low Voltage

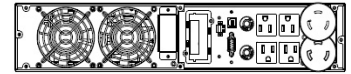
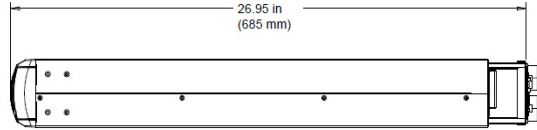
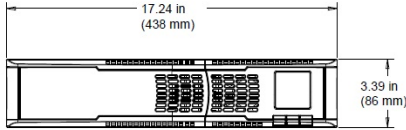

Model Part Number	ACDEF3000-11 17301-01R / 17301-02R
Type	Sinergy III
Power Rating	3000 VA / 2700 W
Topology	On-Line Double Conversion
Heat Dissipation (BTU/Hour)	1756 at 100% Load
Input Voltage (Nominal) Range	100-120 VAC 105-150 VAC
Input Frequency	50/60 Hz ±4 (Auto Sense on Start-Up)
Input Power Factor	>0.95
Input Current THD	<9.0%
Efficiency	>84.0%
Output Voltage	120 VAC (Default) 100/110/115 VAC (Selectable)
Output Current	25.0 A (Default) 30.0/27.3/26.1 A (Selectable)
Voltage Regulation	±1.0%
Overload Online Mode	100-105%: Continuous; Warning Only 105-130%: 2 Minutes 130-200%: 10 Seconds >200%: 250 Milliseconds
Overload Battery Mode	100-105%: Continuous; Warning Only 105-130%: 10 Seconds >130%: 250 Milliseconds
Overload Bypass Mode	100-110%: Continuous; Warning Only 110-120%: 30 Minutes 120-130%: 10 Minutes >130%: 1 Minute
Battery Voltage (Float / Nominal)	82.1/72.0 VDC
Charger Current	1.0 A
Backup Time (Full Load)	>3.6 Minutes
Communications Interface	USB / RS-232
Shipping Weight	81.0 lbs. / 36.8 kg.

SPECIFICATIONS CONT.

SINERGY III UPS (100 - 120 Volt UPS's) specifications cont.



SPECIFICATIONS

Front Panel Controls

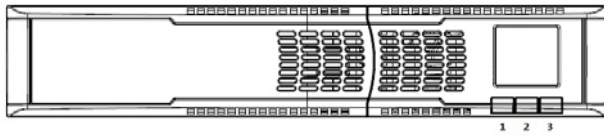

1. ON / MUTE - UP KEY (Previous Selection)
2. SELECT - DOWN KEY (Next Selection)
3. OFF / ENTER - CONFIRM KEY

Front Panel Display

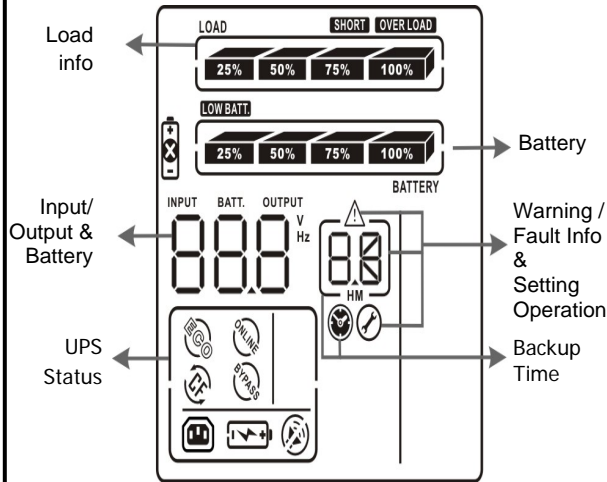

Rear Panel Information and Controls

- 6 Foot Line Cord with NEMA L5-30P **(17301-01R Only, 2400 W Capability)**
- 6 Foot Line Cord with NEMA 6-50P **(17301-02R Only, 2700 W Capability)**
- (2) NEMA 5-20R
- (2) NEMA 5-20R Programmable
- (1) NEMA 5-30R (1 Foot Cord) Direct
- USB & RS-232 Communication
- SNMP Adapter (Optional)
- Internal Relay Contact Card (Optional)
- (2) Circuit Breakers

Internal Batteries

- User Hot-Swappable (See Instruction Manual)
- Type - 12 V, 8.5 AH
- Quantity - 6 Batteries
- Recharge time - 12 Hours to 100%

Environmental

- Temperature: 0 to 40°C (32 to 104°F) Operating
-20 to 50°C (-40 to 122°F) Shipment, Storage
- Humidity: <90% Non-Condensing (Operating, Shipment, Storage)
- Altitude: <1000m Operating, No De-Rating
>1000m De-Rate Output 1% per 100m

Safety Agency and EMC Compliance

All units are listed by UL, and marked with the UL/cUL marking.

Product Listings

- UL1778
- cUL to CSA22.2 No.107.1

Product Compliances

- FCC Part 15J Class A
- IEC61000-4-2, Electrostatic Discharge
- IEC61000-4-3, Radiated Electromagnetic Field Immunity
- IEC61000-4-4, Electrical Fast Transient/Burst Immunity
- IEC61000-4-5, Surge Immunity
- IEC61000-4-6, CS
- IEC61000-4-8, Power Frequency Magnetic Field
- IEC61000-2-2, Low Frequency Signal
- RoHS

Warranty/Support: Sinergy III Series products (hereafter referred to as "Product") are warranted to be free from defects in material and workmanship for **two (2) years** from date of shipment from POWERVAR, on the chassis & electronic components and **two (2) years** from date of shipment from POWERVAR on the batteries. This warranty is limited to repairing, replacing, or refurbishing, at POWERVAR's option, any defective component, circuit board or module within the Product. This warranty will include, at POWERVAR's sole discretion, on-site service or POWERVAR depot service. See the Limitations of Warranty section below for additional limitations & exclusions.

Battery Life Disclaimer: POWERVAR's standard battery warranty applies only to UPS and UPM products which are continuously connected to AC mains power, except during utility power outages. Products which are regularly and intentionally disconnected from AC mains power will experience battery discharge/charge cycles potentially far more numerous than those for which the battery was designed. As a result, products used in such applications will experience substantially reduced battery life. For that reason, POWERVAR's standard battery warranty does not apply for applications in which the UPS or UPM product is regularly and intentionally disconnected from AC mains power. POWERVAR UPS and UPM products used in such applications shall receive a 90 day warranty on batteries.

POWERVAR, Inc. - 1450 Lakeside Drive, Waukegan, IL 60085

POWERVAR, Ltd. - Unit 5 Birch, Kembrey Park, Swindon, Wiltshire, UK SN2 8UU

SPECIFICATIONS CONT.

10.2 SINERGY III UPS (200 - 240 Volt UPS) Specifications



SPECIFICATIONS

Sinergy III Series UPS
2000 VA High Voltage

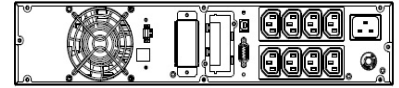
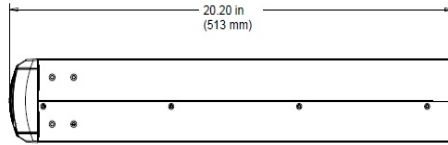
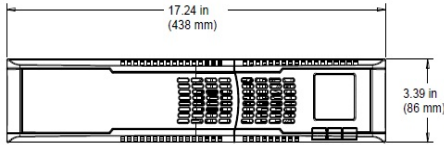

Model Part Number	ACDEF2000-22 17202-01R
Type	Sinergy III
Power Rating	2000 VA / 1800 W
Topology	On-Line Double Conversion
Heat Dissipation (BTU/Hour)	1000 at 100% Load
Input Voltage (Nominal) Range	200-240 VAC 180-300 VAC
Input Frequency	50/60 Hz \pm 4 (Auto Sense on Start-Up)
Input Power Factor	>0.95
Input Current THD	<9.0%
Efficiency	>86.0%
Output Voltage	208 VAC (Default) 200/220/230/240 VAC (Selectable)
Output Current	9.6 A (Default) 10.0/9.1/8.7/8.3 A (Selectable)
Voltage Regulation	\pm 1.0%
Overload Online Mode	100-105%: Continuous; Warning Only 105-130%: 2 Minutes 130-200%: 10 Seconds >200%: 250 Milliseconds
Overload Battery Mode	100-105%: Continuous; Warning Only 105-130%: 10 Seconds >130%: 250 Milliseconds
Overload Bypass Mode	100-110%: Continuous; Warning Only 110-120%: 30 Minutes 120-130%: 10 Minutes >130%: 1 Minute
Battery Voltage (Float / Nominal)	54.7/48.0 VDC
Charger Current	1.0 A
Backup Time (Full Load)	>3.6 Minutes
Communications Interface	USB / RS-232
Shipping Weight	60.0 lbs. / 27.3 kg.

SPECIFICATIONS CONT.

SINERGY III UPS (200 - 240 Volt UPS's) specifications cont.



SPECIFICATIONS

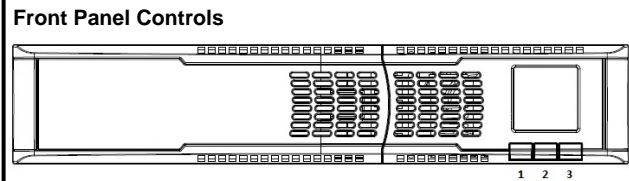

Front Panel Controls

1. ON / MUTE - UP KEY (Previous Selection)
2. SELECT - DOWN KEY (Next Selection)
3. OFF / ENTER - CONFIRM KEY

Front Panel Display

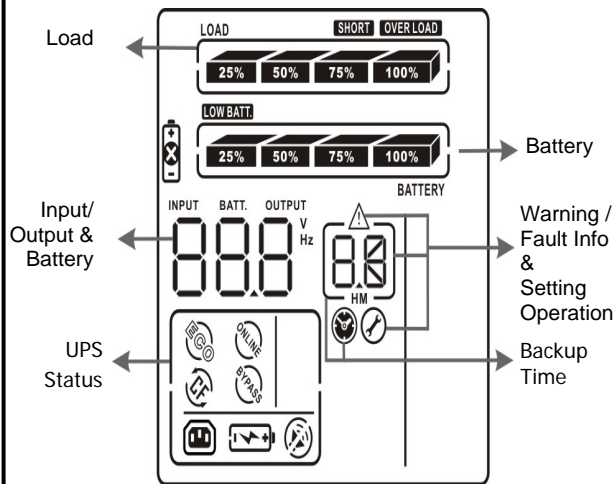

Rear Panel Information and Controls

- 6 Foot Detachable Line Cord with NEMA L6-20P
- (4) IEC320-C13 Direct
- (4) IEC320-C13 Programmable
- USB & RS-232 Communication
- SNMP Adapter (Optional)
- Internal Relay Contact Card (Optional)
- Circuit Breaker

Internal Batteries

- User Hot-Swappable (See Instruction Manual)
- Type - 12 V, 8.5 AH
- Quantity - 4 Batteries
- Recharge time - 12 Hours to 100%

Environmental

- Temperature: 0 to 40°C (32 to 104°F) Operating
-20 to 50°C (-40 to 122°F) Shipment, Storage
- Humidity: <90% Non-Condensing (Operating, Shipment, Storage)
- Altitude: <1000m Operating, No De-Rating
>1000m De-Rate Output 1% per 100m

Safety Agency and EMC Compliance

All units are listed by UL, and marked with the UL/cUL marking.

Product Listings

- UL1778
- cUL to CSA22.2 No.107.1

Product Compliances

- FCC Part 15J Class A
- IEC61000-4-2, Electrostatic Discharge
- IEC61000-4-3, Radiated Electromagnetic Field Immunity
- IEC61000-4-4, Electrical Fast Transient/Burst Immunity
- IEC61000-4-5, Surge Immunity
- IEC61000-4-6, CS
- IEC61000-4-8, Power Frequency Magnetic Field
- IEC61000-2-2, Low Frequency Signal
- RoHS

Warranty/Support: Sinergy III Series products (hereafter referred to as "Product") are warranted to be free from defects in material and workmanship for **two (2) years** from date of shipment from POWERVAR, on the chassis & electronic components and **two (2) years** from date of shipment from POWERVAR on the batteries. This warranty is limited to repairing, replacing, or refurbishing, at POWERVAR's option, any defective component, circuit board or module within the Product. This warranty will include, at POWERVAR's sole discretion, on-site service or POWERVAR depot service. See the Limitations of Warranty section below for additional limitations & exclusions.

Battery Life Disclaimer: POWERVAR's standard battery warranty applies only to UPS and UPM products which are continuously connected to AC mains power, except during utility power outages. Products which are regularly and intentionally disconnected from AC mains power will experience battery discharge/charge cycles potentially far more numerous than those for which the battery was designed. As a result, products used in such applications will experience substantially reduced battery life. For that reason, POWERVAR's standard battery warranty does not apply for applications in which the UPS or UPM product is regularly and intentionally disconnected from AC mains power. POWERVAR UPS and UPM products used in such applications shall receive a 90 day warranty on batteries.

POWERVAR, Inc. - 1450 Lakeside Drive, Waukegan, IL 60085

POWERVAR, Ltd. - Unit 5 Birch, Kembrey Park, Swindon, Wiltshire, UK SN2 8UU

SPECIFICATIONS CONT.

SINERGY III UPS (200 - 240 Volt UPS's) specifications cont.



SPECIFICATIONS

Sinergy III Series UPS
3000 VA High Voltage

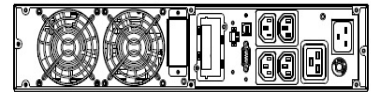
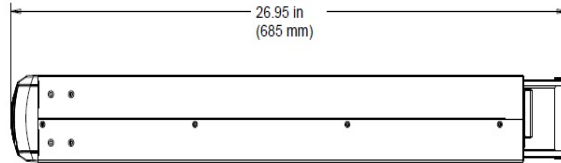
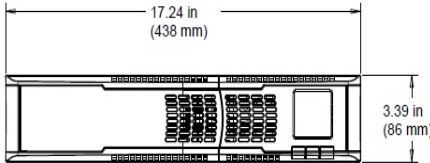

Model Part Number	ACDEF3000-22 17302-01R
Type	Sinergy III
Power Rating	3000 VA / 2700 W
Topology	On-Line Double Conversion
Heat Dissipation (BTU/Hour)	1500 at 100% Load
Input Voltage (Nominal) Range	200-240 VAC 180-300 VAC
Input Frequency	50/60 Hz \pm 4 (Auto Sense on Start-Up)
Input Power Factor	>0.95
Input Current THD	<9.0%
Efficiency	>86.0%
Output Voltage	208 VAC (Default) 200/220/230/240 VAC (Selectable)
Output Current	14.4 A (Default) 15.0/13.6/13.0/12.5 A (Selectable)
Voltage Regulation	\pm 1.0%
Overload Online Mode	100-105%: Continuous; Warning Only 105-130%: 2 Minutes 130-200%: 10 Seconds >200%: 250 Milliseconds
Overload Battery Mode	100-105%: Continuous; Warning Only 105-130%: 10 Seconds >130%: 250 Milliseconds
Overload Bypass Mode	100-110%: Continuous; Warning Only 110-120%: 30 Minutes 120-130%: 10 Minutes >130%: 1 Minute
Battery Voltage (Float / Nominal)	82.1/72.0 VDC
Charger Current	1.0 A
Backup Time (Full Load)	>3.6 Minutes
Communications Interface	USB / RS-232
Shipping Weight	83.0 lbs. / 37.7 kg.

SPECIFICATIONS CONT.

SINERGY III UPS (200 - 240 Volt UPS's) specifications cont.



SPECIFICATIONS

Front Panel Controls

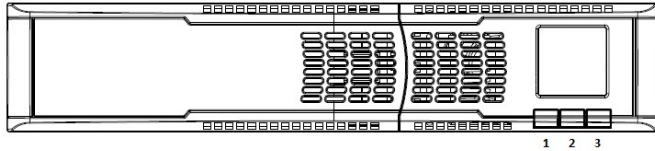

1. ON / MUTE - UP KEY (Previous Selection)
2. SELECT - DOWN KEY (Next Selection)
3. OFF / ENTER - CONFIRM KEY

Front Panel Display

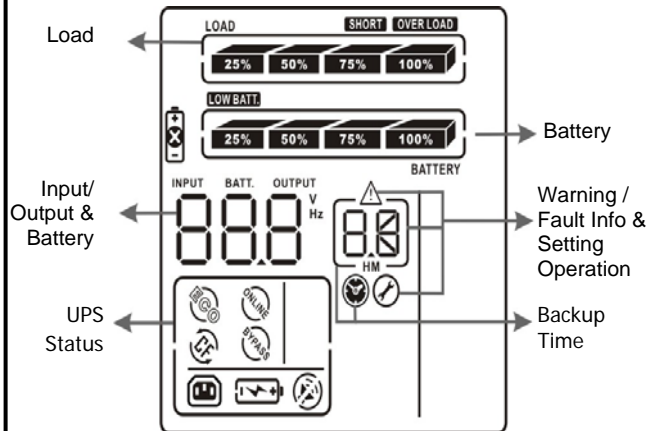

Rear Panel Information and Controls

- 6 Foot Detachable Line Cord with NEMA L6-20P
- (2) IEC320-C13
- (2) IEC320-C13 Programmable
- (1) IEC320-C19 Direct
- USB & RS-232 Communication
- SNMP Adapter (Optional)
- Internal Relay Contact Card (Optional)
- Circuit Breaker

Internal Batteries

- User Hot-Swappable (See Instruction Manual)
- Type - 12 V, 8.5 AH
- Quantity - 6 Batteries
- Recharge time - 12 Hours to 100%

Environmental

- Temperature: 0 to 40°C (32 to 104°F) Operating
-20 to 50°C (-40 to 122°F) Shipment, Storage
- Humidity: <90% Non-Condensing (Operating, Shipment, Storage)
- Altitude: <1000m Operating, No De-Rating
>1000m De-Rate Output 1% per 100m

Safety Agency and EMC Compliance

All units are listed by UL, and marked with the UL/cUL marking.

Product Listings

- UL1778
- cUL to CSA22.2 No.107.1

Product Compliances

- FCC Part 15J Class A
- IEC61000-4-2, Electrostatic Discharge
- IEC61000-4-3, Radiated Electromagnetic Field Immunity
- IEC61000-4-4, Electrical Fast Transient/Burst Immunity
- IEC61000-4-5, Surge Immunity
- IEC61000-4-6, CS
- IEC61000-4-8, Power Frequency Magnetic Field
- IEC61000-2-2, Low Frequency Signal
- RoHS

Warranty/Support: Sinergy III Series products (hereafter referred to as "Product") are warranted to be free from defects in material and workmanship for **two (2) years** from date of shipment from POWERVAR, on the chassis & electronic components and **two (2) years** from date of shipment from POWERVAR on the batteries. This warranty is limited to repairing, replacing, or refurbishing, at POWERVAR's option, any defective component, circuit board or module within the Product. This warranty will include, at POWERVAR's sole discretion, on-site service or POWERVAR depot service. See the Limitations of Warranty section below for additional limitations & exclusions.

Battery Life Disclaimer: POWERVAR's standard battery warranty applies only to UPS and UPM products which are continuously connected to AC mains power, except during utility power outages. Products which are regularly and intentionally disconnected from AC mains power will experience battery discharge/charge cycles potentially far more numerous than those for which the battery was designed. As a result, products used in such applications will experience substantially reduced battery life. For that reason, POWERVAR's standard battery warranty does not apply for applications in which the UPS or UPM product is regularly and intentionally disconnected from AC mains power. POWERVAR UPS and UPM products used in such applications shall receive a 90 day warranty on batteries.

POWERVAR, Inc. - 1450 Lakeside Drive, Waukegan, IL 60085

POWERVAR, Ltd. - Unit 5 Birch, Kembrey Park, Swindon, Wiltshire, UK SN2 8UU

SPECIFICATIONS CONT.

10.3 Extension battery cabinets for use with Sinergy III



SPECIFICATIONS

Sinergy III Series Battery Cabinet
700 / 1000 VA Low Voltage

Model Part Number	E024-12 17888-02R
Type	Sinergy III
Compatible UPS	ACDEF700-11 / ACDEF1000-11
Voltage (Nominal)	24.0 VDC
Battery Type	12V Flame Retardant Sealed Lead-Acid
Battery Quantity	2 x 2 Strings
Recharge Time	24 Hours (Single Battery Cabinet, 1A Charger)
Length	17.25 in / 438 mm
Height	3.39 in / 86 mm
Depth	16.26 in / 413 mm
Unit Weight	38.0 lbs. / 17.3 kg.
Shipping Weight	47.0 lbs. / 21.4 kg.
Safety Agencies	UL1778 cUL to CSA22.2 No. 107.1

ACDEF700-11 Typical run times with external battery cabinets

Percent Capacity	Watts	Number of Battery Cabinets				
		Internal	INT+1 EXT	INT+2 EXT	INT+3 EXT	INT+4 EXT
Runtimes are expressed in minutes Typical runtimes based on fully charged, new batteries, operating under typical load conditions Times estimated assuming a switch mode power supply Runtimes are affected by battery age, ambient temperature, site specific usage patterns and load conditions						
0	0	203	893	>16 hrs	>16 hrs	>16 hrs
10	56	65	288	573	902	>16 hrs
20	112	35	157	313	492	690
30	168	23	104	206	325	455
40	224	17	75	150	236	331
50	280	13	58	116	183	256
60	336	10	47	94	147	207
70	392	8.9	39	78	122	172
80	448	7.6	33	66	104	146
90	504	6.5	29	57	90	126
100	560	5.7	25	50	79	111

SPECIFICATIONS CONT.

Extension battery cabinets for use with Sinergy III specifications cont.



SPECIFICATIONS

ACDEF1000-11 Typical run times with external battery cabinets

Percent Capacity	Watts	Number of Battery Cabinets				
		Internal	INT+1 EXT	INT+2 EXT	INT+3 EXT	INT+4 EXT
Runtimes are expressed in minutes Typical runtimes based on fully charged, new batteries, operating under typical load conditions Times estimated assuming a switch mode power supply Runtimes are affected by battery age, ambient temperature, site specific usage patterns and load conditions						
0	0	203	893	>16 hrs	>16 hrs	>16 hrs
10	80	48	211	419	659	925
20	160	24	107	212	334	468
30	240	15	68	135	213	298
40	320	11	49	97	152	213
50	400	8.4	37	74	116	163
60	480	6.7	30	59	93	130
70	560	5.6	24	49	77	107
80	640	4.7	20	41	64	90
90	720	4.1	17	35	55	78
100	800	3.5	15	31	48	68

Warranty/Support: Sinergy III Series products (hereafter referred to as "Product") are warranted to be free from defects in material and workmanship for **two (2) years** from date of shipment from POWERVAR, on the chassis & electronic components and **two (2) years** from date of shipment from POWERVAR on the batteries. This warranty is limited to repairing, replacing, or refurbishing, at POWERVAR's option, any defective component, circuit board or module within the Product. This warranty will include, at POWERVAR's sole discretion, on-site service or POWERVAR depot service. See the Limitations of Warranty section below for additional limitations & exclusions.

Battery Life Disclaimer: POWERVAR's standard battery warranty applies only to UPS and UPM products which are continuously connected to AC mains power, except during utility power outages. Products which are regularly and intentionally disconnected from AC mains power will experience battery discharge/charge cycles potentially far more numerous than those for which the battery was designed. As a result, products used in such applications will experience substantially reduced battery life. For that reason, POWERVAR's standard battery warranty does not apply for applications in which the UPS or UPM product is regularly and intentionally disconnected from AC mains power. POWERVAR UPS and UPM products used in such applications shall receive a 90 day warranty on batteries.

POWERVAR, Inc. - 1450 Lakeside Drive, Waukegan, IL 60085
 POWERVAR, Ltd. - Unit 5 Birch, Kembrey Park, Swindon, Wiltshire, UK SN2 8UU

SPECIFICATIONS CONT.

Extension battery cabinets for use with Sinergy III specifications cont.



SPECIFICATIONS

**Sinergy III Series Battery Cabinet
1500 VA Low Voltage**

Model	E036-12
Part Number	17888-03R
Type	Sinergy III
Compatible UPS	ACDEF1500-11
Voltage (Nominal)	36.0 VDC
Battery Type	12V Flame Retardant Sealed Lead-Acid
Battery Quantity	3 x 2 Strings
Recharge Time	24 Hours (Single Battery Cabinet, 1A Charger)
Length	17.25 in / 438 mm
Height	3.39 in / 86 mm
Depth	20.20 in / 513 mm
Unit Weight	53.0 lbs. / 24.1 kg.
Shipping Weight	63.5 lbs. / 28.9 kg.
Safety Agencies	UL1778 cUL to CSA22.2 No. 107.1

ACDEF1500-11 Typical run times with external battery cabinets

Percent Capacity	Watts	Number of Battery Cabinets				
		Internal	INT+1 EXT	INT+2 EXT	INT+3 EXT	INT+4 EXT
Runtimes are expressed in minutes Typical runtimes based on fully charged, new batteries, operating under typical load conditions Times estimated assuming a switch mode power supply Runtimes are affected by battery age, ambient temperature, site specific usage patterns and load conditions						
0	0	351	> 16 hrs	> 16 hrs	> 16 hrs	> 16 hrs
10	120	55	244	485	763	> 16 hrs
20	240	26	115	229	360	505
30	360	16	71	142	223	313
40	480	11	50	100	157	220
50	600	8.6	38	75	119	166
60	720	6.8	30	60	94	132
70	840	5.6	25	49	77	108
80	960	4.7	21	41	65	91
90	1080	4.1	18	35	56	78
100	1200	3.5	16	31	49	68

Warranty/Support: Sinergy III Series products (hereafter referred to as "Product") are warranted to be free from defects in material and workmanship for **two (2) years** from date of shipment from POWERVAR, on the chassis & electronic components and **two (2) years** from date of shipment from POWERVAR on the batteries. This warranty is limited to repairing, replacing, or refurbishing, at POWERVAR's option, any defective component, circuit board or module within the Product. This warranty will include, at POWERVAR's sole discretion, on-site service or POWERVAR depot service. See the Limitations of Warranty section below for additional limitations & exclusions.

Battery Life Disclaimer: POWERVAR's standard battery warranty applies only to UPS and UPM products which are continuously connected to AC mains power, except during utility power outages. Products which are regularly and intentionally disconnected from AC mains power will experience battery discharge/charge cycles potentially far more numerous than those for which the battery was designed. As a result, products used in such applications will experience substantially reduced battery life. For that reason, POWERVAR's standard battery warranty does not apply for applications in which the UPS or UPM product is regularly and intentionally disconnected from AC mains power. POWERVAR UPS and UPM products used in such applications shall receive a 90 day warranty on batteries.

POWERVAR, Inc. - 1450 Lakeside Drive, Waukegan, IL 60085

POWERVAR, Ltd. - Unit 5 Birch, Kembrey Park, Swindon, Wiltshire, UK SN2 8UU

SPECIFICATIONS CONT.

Extension battery cabinets for use with Sinergy III specifications cont.



SPECIFICATIONS

Sinergy III Series Battery Cabinet
2000 VA High / Low Voltage

Model Part Number	E048-12 17888-04R
Type	Sinergy III
Compatible UPS	ACDEF2000-11 / ACDEF2000-22
Voltage (Nominal)	48.0 VDC
Battery Type	12V Flame Retardant Sealed Lead-Acid
Battery Quantity	4 x 2 Strings
Recharge Time	24 Hours (Single Battery Cabinet, 1A Charger)
Length	17.25 in / 438 mm
Height	3.39 in / 86 mm
Depth	20.20 in / 513 mm
Unit Weight	65.0 lbs. / 29.5 kg.
Shipping Weight	75.5 lbs. / 34.3 kg.
Safety Agencies	UL1778 cUL to CSA22.2 No. 107.1

ACDEF2000-11 Typical run times with external battery cabinets

Percent Capacity	Watts	Number of Battery Cabinets				
		Internal	INT+1 EXT	INT+2 EXT	INT+3 EXT	INT+4 EXT
0	0	517	> 16 hrs	> 16 hrs	> 16 hrs	> 16 hrs
10	140	70	309	615	> 16 hrs	> 16 hrs
20	280	32	143	284	447	627
30	420	20	88	175	275	385
40	560	14	61	122	192	270
50	700	10	46	92	145	203
60	840	8.4	37	73	115	161
70	980	6.9	30	60	94	132
80	1120	5.8	25	50	79	111
90	1260	4.9	22	43	68	95
100	1400	4.3	19	38	59	83

Runtimes are expressed in minutes
 Typical runtimes based on fully charged, new batteries, operating under typical load conditions
 Times estimated assuming a switch mode power supply
 Runtimes are affected by battery age, ambient temperature, site specific usage patterns and load conditions

SPECIFICATIONS CONT.

Extension battery cabinets for use with Sinergy III specifications cont.



SPECIFICATIONS

ACDEF2000-22 Typical run times with external battery cabinets

Percent Capacity	Watts	Number of Battery Cabinets				
		Internal	INT+1 EXT	INT+2 EXT	INT+3 EXT	INT+4 EXT
Runtimes are expressed in minutes Typical runtimes based on fully charged, new batteries, operating under typical load conditions Times estimated assuming a switch mode power supply Runtimes are affected by battery age, ambient temperature, site specific usage patterns and load conditions						
0	0	517	> 16 hrs	> 16 hrs	> 16 hrs	> 16 hrs
10	160	60	267	532	836	> 16 hrs
20	320	27	121	242	380	533
30	480	16	74	147	232	325
40	640	11	52	103	162	227
50	800	8.9	39	77	122	171
60	960	7.0	31	61	96	135
70	1120	5.7	25	50	79	111
80	1280	4.8	21	42	66	93
90	1440	4.1	18	36	57	80
100	1600	3.6	16	31	49	69

Warranty/Support: Sinergy III Series products (hereafter referred to as "Product") are warranted to be free from defects in material and workmanship for **two (2) years** from date of shipment from POWERVAR, on the chassis & electronic components and **two (2) years** from date of shipment from POWERVAR on the batteries. This warranty is limited to repairing, replacing, or refurbishing, at POWERVAR's option, any defective component, circuit board or module within the Product. This warranty will include, at POWERVAR's sole discretion, on-site service or POWERVAR depot service. See the Limitations of Warranty section below for additional limitations & exclusions.

Battery Life Disclaimer: POWERVAR's standard battery warranty applies only to UPS and UPM products which are continuously connected to AC mains power, except during utility power outages. Products which are regularly and intentionally disconnected from AC mains power will experience battery discharge/charge cycles potentially far more numerous than those for which the battery was designed. As a result, products used in such applications will experience substantially reduced battery life. For that reason, POWERVAR's standard battery warranty does not apply for applications in which the UPS or UPM product is regularly and intentionally disconnected from AC mains power. POWERVAR UPS and UPM products used in such applications shall receive a 90 day warranty on batteries.

POWERVAR, Inc. - 1450 Lakeside Drive, Waukegan, IL 60085

POWERVAR, Ltd. - Unit 5 Birch, Kembrey Park, Swindon, Wiltshire, UK SN2 8UU

SPECIFICATIONS CONT.

Extension battery cabinets for use with Sinergy III specifications cont.



SPECIFICATIONS

Sinergy III Series Battery Cabinet
3000 VA High / Low Voltage

Model Part Number	E072-12 17888-05R
Type	Sinergy III
Compatible UPS	ACDEF3000-11 / ACDEF3000-22
Voltage (Nominal)	72.0 VDC
Battery Type	12V Flame Retardant Sealed Lead-Acid
Battery Quantity	6 x 2 Strings
Recharge Time	24 Hours (Single Battery Cabinet, 1A Charger)
Length	17.25 in / 438 mm
Height	3.39 in / 86 mm
Depth	24.92 in / 633 mm
Unit Weight	91.5 lbs. / 41.6 kg.
Shipping Weight	105.0 lbs. / 47.4 kg.
Safety Agencies	UL1778 cUL to CSA22.2 No. 107.1

ACDEF3000-11 Typical run times with external battery cabinets

Percent Capacity	Watts	Number of Battery Cabinets				
		Internal	INT+1 EXT	INT+2 EXT	INT+3 EXT	INT+4 EXT
0	0	413	> 16 hrs	> 16 hrs	> 16 hrs	> 16 hrs
10	210	64	283	562	885	> 16 hrs
20	420	31	137	272	427	600
30	630	19	85	170	267	375
40	840	13	60	120	189	265
50	1050	10.4	46	91	143	201
60	1260	8.3	36	72	114	160
70	1470	6.8	30	60	94	131
80	1680	5.7	25	50	79	111
90	1890	4.9	22	43	68	95
100	2100	4.3	19	38	59	83

Runtimes are expressed in minutes
 Typical runtimes based on fully charged, new batteries, operating under typical load conditions
 Times estimated assuming a switch mode power supply
 Runtimes are affected by battery age, ambient temperature, site specific usage patterns and load conditions

SPECIFICATIONS CONT.

Extension battery cabinets for use with Sinergy III specifications cont.



SPECIFICATIONS

ACDEF3000-22 Typical run times with external battery cabinets

Percent Capacity	Watts	Number of Battery Cabinets				
		Internal	INT+1 EXT	INT+2 EXT	INT+3 EXT	INT+4 EXT
Runtimes are expressed in minutes Typical runtimes based on fully charged, new batteries, operating under typical load conditions Times estimated assuming a switch mode power supply Runtimes are affected by battery age, ambient temperature, site specific usage patterns and load conditions						
0	0	351	> 16 hrs	> 16 hrs	> 16 hrs	> 16 hrs
10	240	56	247	491	772	> 16 hrs
20	480	26	117	232	365	512
30	720	16	72	144	226	318
40	960	11	51	101	159	223
50	1200	8.8	38	77	120	169
60	1440	7.0	31	61	96	134
70	1680	5.7	25	50	78	110
80	1920	4.8	21	42	66	93
90	2160	4.1	18	36	57	80
100	2400	3.6	16	31	49	69

Warranty/Support: Sinergy III Series products (hereafter referred to as "Product") are warranted to be free from defects in material and workmanship for **two (2) years** from date of shipment from POWERVAR, on the chassis & electronic components and **two (2) years** from date of shipment from POWERVAR on the batteries. This warranty is limited to repairing, replacing, or refurbishing, at POWERVAR's option, any defective component, circuit board or module within the Product. This warranty will include, at POWERVAR's sole discretion, on-site service or POWERVAR depot service. See the Limitations of Warranty section below for additional limitations & exclusions.

Battery Life Disclaimer: POWERVAR's standard battery warranty applies only to UPS and UPM products which are continuously connected to AC mains power, except during utility power outages. Products which are regularly and intentionally disconnected from AC mains power will experience battery discharge/charge cycles potentially far more numerous than those for which the battery was designed. As a result, products used in such applications will experience substantially reduced battery life. For that reason, POWERVAR's standard battery warranty does not apply for applications in which the UPS or UPM product is regularly and intentionally disconnected from AC mains power. POWERVAR UPS and UPM products used in such applications shall receive a 90 day warranty on batteries.

POWERVAR, Inc. - 1450 Lakeside Drive, Waukegan, IL 60085
 POWERVAR, Ltd. - Unit 5 Birch, Kembrey Park, Swindon, Wiltshire, UK SN2 8UU

**11. APPENDIX B: Optional Isolated Relay Contacts Card
 Model ISO-BASIC
 POWERVAR Part Number 17999-01R**

Installation and Operation

11.1 Description

The isolated relay contacts card is an auxiliary interface card which provides isolated dry contact signals that indicate the status of the UPS to a locally connected system. The card also has a isolated input that the locally connected system can use to shut down the UPS.

11.2 Installation in Sinergy III UPS Accessory Slot

To install the isolated contacts interface card:

1. Turn off and unplug the UPS during the installation.
2. Remove the slot cover plate (two screws) on the back of the unit.
3. Firmly slide the card into the slot.
4. Replace the two screws to secure interface card.

NOTE: For Nortel Meridian systems, see Instructions for Nortel Meridian PBX Systems on page 41.

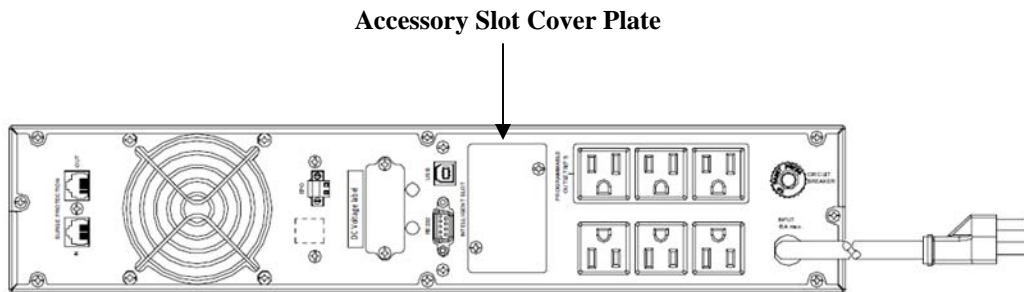

Figure B1 : Slot Cover Plate Model ACDEF1000-11

11.3 Isolated Relay Contact Card Operation

The isolated contacts interface card (see Figure B4) is an auxiliary interface card which provides isolated dry contact signals which indicate:

- Failure of AC source into the UPS.
- A low battery-charge state when the UPS is running from battery.
- UPS is in the BYPASS mode (not on line). There are two modes to select:
 - *N/C Contact* - (factory default), JP3 jumpered 1 to 2. See Figure B7.
 - *N/O Contact* - JP3 jumpered 2 to 3.
- Summary Alarm. There are two modes to select:
 - *N/C Contact* - (factory default), JP1 jumpered 2 to 3. See Figure B6.
 - *N/O Contact* - JP3 jumpered 1 to 2.
- A fifth signal will turn off the UPS inverter system. This signal capability is provided for computer-based systems that can signal when the operating system has been shut down and the UPS battery backup is no longer needed by the system. This conserves any remaining battery charge for subsequent power failures that may occur before the UPS battery has been recharged. A one second delay is standard. See Figure B8 on page 40 for isolated contact interface card connector pin numbers and functions.

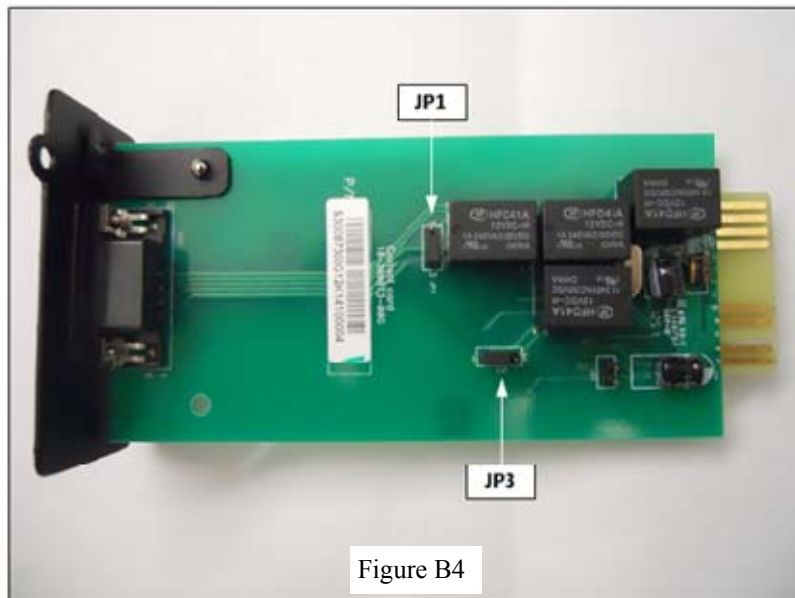

Figure B5
DB9 Connector



Figure B6
JP1 jumpered 2 to 3



Figure B7
JP3 jumpered 1 to 2

11.4 Isolated Relay Contact Card Functional Diagrams

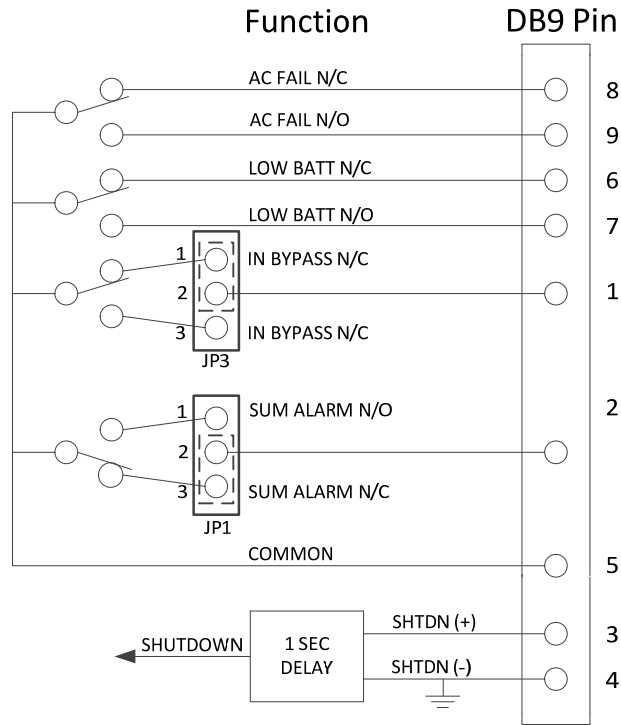

Figure B8 : Simplified Schematic of Interface Connections

Function	Pin
AC FAIL NC	8
AC FAIL NO	9
LOW BATTERY NC	6
LOW BATTERY NO	7
BYPASS	1
ALARM	2
COMMON	5
SHUTDOWN (+)	3
SHUTDOWN (-)	4

11.5 Isolated Relay Contact Card Specifications

The isolated relay circuit is rated as follows :

- 1 Amp @ 125VAC
- 1 Amp @ 30VDC
- 100 mA @ 125VDC

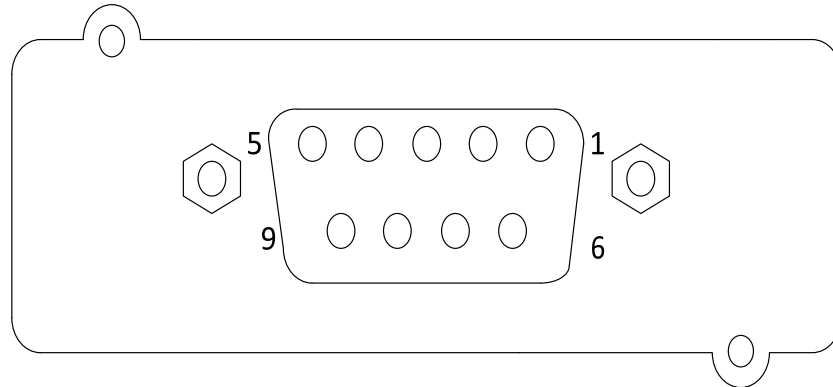

Figure B9 : DB9 Output Connector Isolated Contacts Card

11.6 Instructions for Nortel Meridian PBX Systems

Use Cable part number CA-NTMeridian for Connecting Nortel Meridian PBX Systems to the Isolated Relay Contact Card

Cable (CA-NTMeridian) should be connected between the 9-pin port on the isolated contacts card in the UPS and the system monitor (SYSMON) card installed in the Meridian system.

Refer to the Nortel Meridian documentation for details on configuring the system monitor for logging UPS information.

Suggested references:

- Meridian 1 System Installation and Maintenance (PO842839)
- Meridian 1 XII System Messages (PO842845)

For POWERVAR Sinergy III Series UPS only:

- Alarm condition 1 should be interpreted as AC fail, inverter on.
- Alarm condition 2 should be interpreted as an indication of low battery condition. This condition is a normal condition that occurs during an extended power failure.

12. APPENDIX C : Warranty

12.1 Basic Warranty

Sinergy III Series products (hereafter referred to as “Product”) are warranted to be free from defects in material and workmanship for **two (2) years** from date of shipment from POWERVAR, on the chassis & electronic components and **two (2) years** from date of shipment from POWERVAR on the batteries. This warranty is limited to repairing, replacing, or refurbishing, at POWERVAR’s option, any defective component, circuit board or module within the Product. This warranty will include, at POWERVAR’s sole discretion, on-site service or POWERVAR depot service. See the Limitations of Warranty section below for additional limitations & exclusions.

12.2 Limitations

This limited warranty does not cover any losses or damage resulting from shipment to or from the Customer, or from improper installation, improper application, inappropriate environment, abuse, neglect, unauthorized modifications, adjustments, or repair of the Product. Additionally, any costs related to installation or de-installation of the Product for the purpose of replacement or servicing will be the Customer’s sole responsibility. POWERVAR makes no warranties, expressed or implied, of merchantability, fitness for a particular purpose, performance, condition, capacity, or otherwise. POWERVAR is not liable for incidental or consequential damages, monetary loss, loss of sales, or loss of business resulting from the failure or malfunction of the Product. Warranty is void on Product where evidence of tampering exists. Improper long-term storage may damage the UPS batteries and invalidate the battery warranty. Disconnecting a UPS from its AC utility power source for an extended period of time results in lost battery charge. To keep the batteries fully charged and maximize the life of the batteries, connect the UPS to an AC power source while it is in storage. If this is not possible, the UPS must be connected to a power source for 24 hours at least once every 4 months, or every 2 months if the ambient temperature is more than 30°C (86°F). Additionally, POWERVAR’s warranty on batteries applies only to Products that are continuously connected to AC mains power, except during utility power outages. Products that are regularly and intentionally disconnected from AC mains power will experience battery discharge/charge cycles that are potentially far more numerous than those for which the battery was designed. As a result, Products used in such applications will experience substantially reduced battery life. Therefore, POWERVAR’s standard warranty term does not apply in these cases and is supplanted by a **90 day** warranty from time of shipment from POWERVAR. The warranty provided by POWERVAR provides for the replacement of the battery or battery systems in the event that the batteries do not meet the performance specifications as determined by POWERVAR exclusively. All warranty services will be performed during POWERVAR normal, non-holiday business hours (Monday through Friday, 8:00 AM – 5:00 PM CST). Any service required by Customer to be performed outside of normal business hours will be subject to POWERVAR’s prevailing labor rates.

12.3 Battery Life Disclaimer

POWERVAR’s standard battery warranty applies only to UPS and UPM products which are continuously connected to AC mains power, except during utility power outages. Products which are regularly and intentionally disconnected from AC mains power will experience battery discharge/charge cycles potentially far more numerous than those for which the battery was designed. As a result, products used in such applications will experience substantially reduced battery life. For that reason, POWERVAR’s standard battery warranty does not apply for applications in which the UPS or UPM product is regularly and intentionally disconnected from AC mains power. POWERVAR UPS and UPM products used in such applications shall receive a 90 day warranty on batteries.